

BATTLETROOPS™

A GAME OF URBAN MAN-TO-MAN COMBAT IN THE BATTLETECH UNIVERSE



EDM

CONTENTS

BATTLETROOPS	4
Components	4
Counters	4
Stand-Up Figures	4
Firing Arcs	4
Hand Grenades	4
HE Impact	4
Breach	4
Rubble and Splinters	4
Flames	5
'Mech Weapons	5
Floor	5
Prone	5
Vehicle Template	5
'Mech Template	5
Fallen 'Mech Template	5
Mapsheets	6
Buildings	6
Undergrowth	6
Trees	6
Contour Lines	6
Record Sheets	6
Dice	6
PREPARATION FOR PLAY	7
Mapsheet Layout	7
Filling Out the Record Sheet	7
SEQUENCE OF PLAY	8
Initiative Phase	8
Movement Phase	8
End Phase	8
MOVEMENT	9
Movement Points	9
Movement Costs	9
Stairways	10
Placement of Firing Arcs	10
Going Prone	11
Standing Up	11
Prepare Weapon/Grenade	11
Throw Grenade	11
Stacking	11
COMBAT	12
Firing Arc	12
Line-of-Sight	12
Terrain Elevation Dead Zones	13
Ranged Combat	14
Base To-Hit Number	14
To-Hit Modifiers	14
Hand-to-Hand Combat	14
Resolve Attack	15
Damage	15
Damage Effects	16
SPECIAL WEAPONS AND EQUIPMENT	17
Hand Grenades	17
Grenade Damage	18
Armor	18
OPTIONAL RULES	20
Weapons	20
Exchanging Weapons/Ammo	20
Area-Effect Weapons	20
Support Weapons	21
Jump Troops	22
Leadership	22
Experience Level	22
Morale	23
Leaders	23
MechWarrior Integration	23
Weapon Conversion	23
BattleTech/CityTech Integration	24
Filling Out the 'Mech Record Sheet	24
Movement	25
Combat	28
Heat	30
Consciousness Rolls	30
Anti-'Mech Fire	30
Mines	31
Fire	31
Buildings	31
Vehicles	32
Movement	32
Combat	32
Riding Vehicles	32
Open Hatch	33
Crew Abandonment	33
Hidden Units	33
Vehicle Vs. Vehicle or 'Mech Combat	33
Movement	33
Fire Combat	33
Physical Combat	33
PLATOON ORGANIZATION	34
SCENARIOS	36
Side Show	36
Dragon Hunting	37
Race Against Time	38

BATTLETROOPS

Game Design

Sam Lewis
Jordan Weisman
L. Ross Babcock III

Writing

Sam Lewis

Playtesters

Dave Wylie
Michael Hebert
Arthur Alford
Bill Allen
Quentin Doucet
Clay James
Eddie Moss
David Shorey
The Ariston Game Club
Bill Webb
Eric J Smith
Kevin William
Christina
Phil Schumer
Laura Lee
Dave Brave
Plastics & Tactics
Al Davis
Pat Searles
Gray Griess
Kermit Melson
Craig Rollis

Editorial Staff

Editor-In-Chief
L. Ross Babcock III
Senior Editor
Donna Ippolito
Editor
Jim Musser
Editorial Assistant
C. R. Green
Research Assistant
Kent Stolt

Production Staff

Production Managers
Jordan K. Weisman
Sam Lewis
Art Director
Dana Knutson
Production Coordinator
Tara Gallagher
Project Manager
Joel Biske
Cover Art
Tom Miller
Box Design
Jeff Laubenstein
Dana Knutson
Counters
Hanzo
Maps
Dana Elvis Knutson
Illustration
Joel Biske
Photo Credits
Michael L. Weaver
Ral Partha Enterprises
Diagrams
Jonathan Marcus
Layout
Tara Gallagher

BATTLETROOPS

In the 31st Century, warfare is dominated by BattleMechs, giant armored machines of destruction carrying a massive array of weapons. But even these behemoths can be brought to their knees by a team of determined men.

BattleTroops is a game of man-to-man combat in the 31st Century. Players can command up to 28 foot soldiers in city battles. Optional rules provide for integrating **BattleTroops** with FASA's **BattleTech** and **MechWarrior** games.

COMPONENTS

BattleTroops includes everything players need to play the game. Before reading the rules, check the contents of the box against the following list to make sure all pieces are here.

- 1 rulebook
- Four 22x34-inch mapsheets
- Two 11x17-inch counter sheets
- 16 Card stands
- 2 Six-sided dice

COUNTERS

BattleTroops uses stand-up counters to represent individual soldiers as well as a variety of flat counters and templates to represent unit status, vehicles, firing arcs, and so on. These are discussed separately.

STAND-UP FIGURES

The game of **BattleTroops** includes 16 stand-up figures, each representing one infantryman and showing the front and back of a soldier. To assemble these figures, fold the counter as shown in the diagram below.

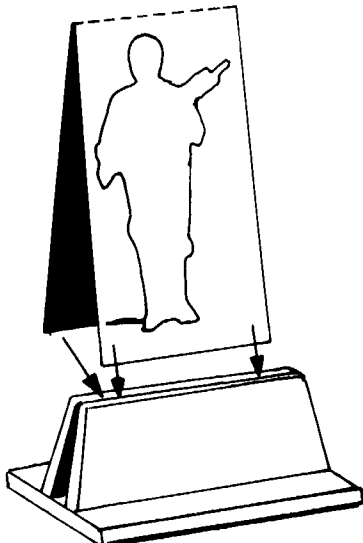

FIRING ARCS

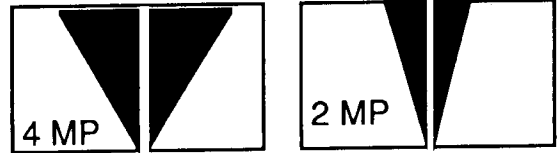

Firing Arc counters show what area a soldier has under observation. They are placed after the soldier has finished his movement. Any soldier who enters the Firing Arc of an enemy infantryman can be attacked.

HAND GRENADES

Hand Grenade counters show that a soldier has prepared a hand grenade for throwing and then show where a live grenade has landed.



HE IMPACT



These counters show that a soldier has prepared an area-effect weapon for firing and then show the impact location.

BREACH

Breach counters are used with the Optional Rules to indicate a hole in the wall of a building.



RUBBLE AND SPLINTERS

These counters symbolize what remains of buildings and trees after a Mech has walked through them. Rubble counters are centered on the interior dot of the destroyed building. Splinter counters are placed over the tree.



FLAMES

These counters mark areas that have caught fire. They should be centered on each dot that is on fire.

'MECH WEAPONS

These counters designate firing arcs on the 'Mech Template. Note that there are no counters for weapons mounted in the Head, Center Torso, Legs, or Rear. Weapons mounted in these areas can fire only into the Forward or Rear (Rear-mounted weapons only) arcs.

FLOOR

Floor counters indicate which floor of a building a soldier is on.

PRONE

Prone counters indicate that a soldier is lying down.

VEHICLE TEMPLATE

The Vehicle Template is used in advanced scenarios that involve a combat vehicle. The firing arcs for its weapons are defined as shown.

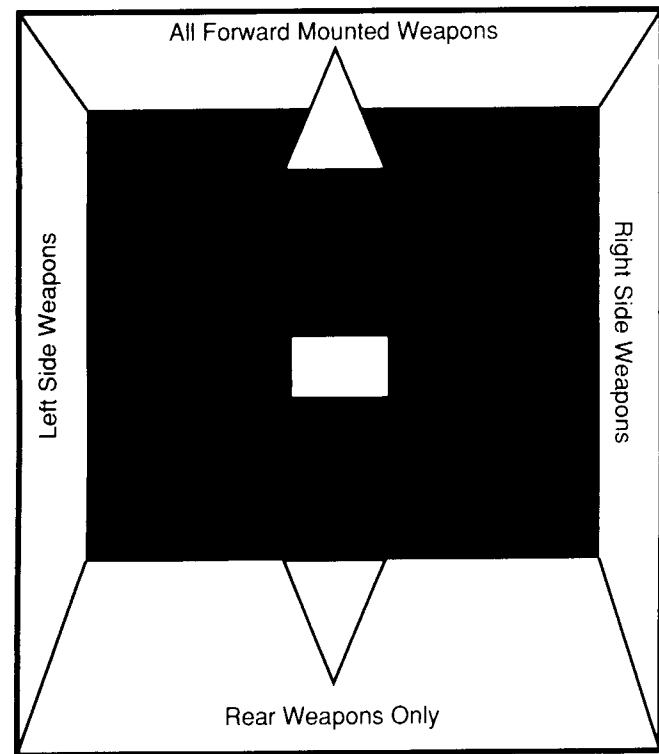

'MECH TEMPLATE

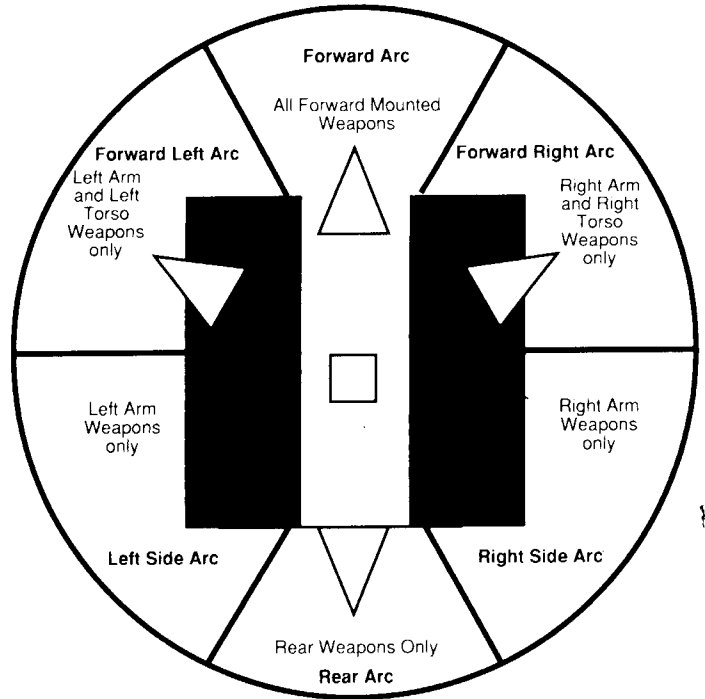

The 'Mech Template is used when a BattleMech is present in an advanced scenario. The firing arcs of the 'Mech's weapons are defined as shown on the template.

FALLEN 'MECH TEMPLATE

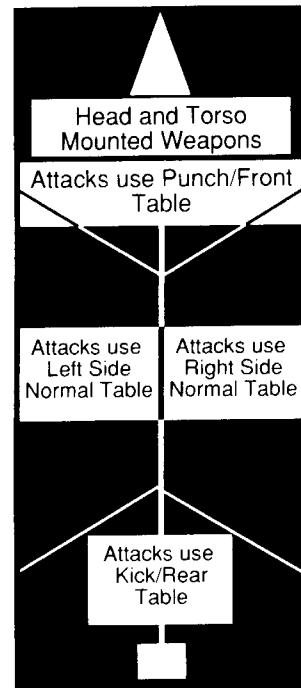

This template is used to indicate a fallen 'Mech.

BATTLETROOPS

MAPSHEETS

Four 22 x 34-inch mapsheets are included in the game. One side of the map represents a typical city area, while the other side has no features so that players can make their own maps.

To regulate movement and combat, the map has a dot pattern. Soldiers move from dot to dot. The distance between dots is 2.5 meters, and each turn represents 5 seconds of real time.

Terrain affects both movement and combat. Most types of terrain have solid black areas and shaded areas. The solid area blocks line of sight, and the shaded area represents partial cover.

BUILDINGS

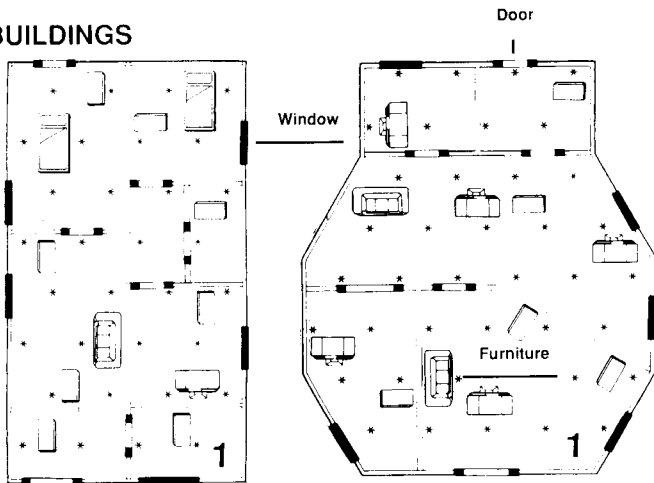

The main terrain features on the city maps are the buildings. Buildings consist of various components, as shown above.

The height of each building is listed on the map in terms of elevation levels, with each elevation level or story equal to about 3 meters. The First or Ground Floor has an elevation of 0, the Second Floor has an elevation of 1, and so forth. The top floor is the roof, which has an elevation equal to the building's height. Any building with a Stairway also has a basement, which is considered to have an elevation of -1. Elevation 1 buildings do not have basements.

For purposes of this game, the floor plan for all stories of a building are exactly the same, with the same window and interior wall placement, except that the exterior doors are assumed to be only on the ground floor, that basements have no windows or exterior doors, and that the roof of the building is open, with no surrounding walls, windows, or other features.

Buildings are also rated, on the map, according to their differences in construction to show the damage that they can withstand. Buildings can be rated Light, Medium, Heavy, or Hardened. These ratings are used with the Optional Rules.

UNDERGROWTH

Undergrowth represents short bushes and small scrub trees one to three meters tall. Undergrowth hampers movement and can hide soldiers who are prone behind it, but it provides little protection from small-arms fire.

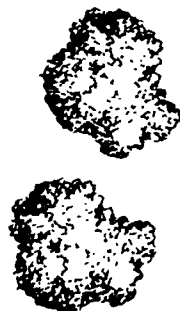

TREES

Trees represent a single tree that is at least 6 meters tall and has a thick trunk. Trees have two components, a trunk and branches. The trunk blocks fire and hides anyone directly behind it. Branches are like undergrowth, only slightly reducing the effect of enemy fire and not blocking line-of-sight.

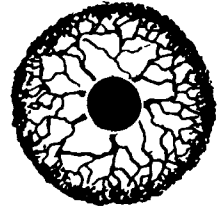

CONTOUR LINES

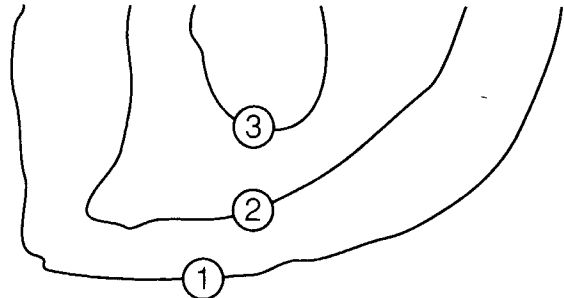

The mapsheets provided in **BattleTroops** represent flat terrain. To represent hills, use contour lines. Each line represents a one-level change in elevation (about 3 meters). The absolute elevation level should be marked on the contour line. Contour lines go between dots, and units are considered to be at the lower elevation. For example, a soldier on a dot between a Level 2 and a Level 3 contour line would be considered at an elevation of 2.

RECORD SHEETS

10	9	8	7	6	5	4	3	2	1	0	DEAD
8	8	8	+1	+1	+2	+2	+2	+3	+3	None	
Troop Number _____		Primary Weapon Type: _____ MP _____									
HG	○	○	○	○	Dmg: _____		Short _____		Long _____		
Other	○	○	○	○	Secondary Weapon Type: _____		MP _____				
Ammo	○	○	○	○	Dmg: _____		Short _____		Long _____		

The Record Sheet is used to keep track of the status of each soldier in a squad, including his weapon and the number of grenades or satchel charges he is carrying. Each Record Sheet has seven different records on it to represent the members of a squad. The upper left hand area is used to indicate squad information, such as Experience Level and Leadership Rating. The use of the Record Sheet is explained in the Preparation for Play, Combat, and Damage sections of the rules.

A soldier's record block consists of his Physical Status Track, his ID number, primary and secondary weapons carried, along with areas to indicate the damage that those weapons do and their short and long ranges. Finally, the Record Sheet has an area to record the number of hand grenades and other limited ammunition that the soldier is carrying.

DICE

BattleTroops uses 2 six-sided dice. As a convention, 1D6 means that only 1 six-sided die is to be rolled. 2D6 indicates that 2 six-sided dice are to be rolled.

PREPARATION FOR PLAY

Before play begins, players decide on whether to use a published scenario or one of their own design. They should then choose sides and fill out Record Sheets for all of the soldiers being used in the battle. From that point on, the players should simply follow the Sequence of Play and the rules given for each phase.

MAPSHEET LAYOUT

Lay out two or more mapsheets on a table or a floor in a way agreeable to all players. If furniture or other counters are called for by the scenario, place them on the mapsheet now. This can be done randomly, or players can take turns choosing where to place the counters.

FILLING OUT THE RECORD SHEET

Before the game starts, each player must fill out a Record Sheet for each of his squads. The player should take one Record Sheet for every seven men (a squad) that he controls. If using the optional Leadership and Morale rules, the Experience Level and Leadership Rating of the squad should be indicated on the sheet, along with the Troop ID Number of that squad's leader.

Firearms and other weapons should be allocated to individual soldiers as detailed in the scenario. In the Basic Game, each soldier in a squad carries only one personal firearm, four grenades, and a bayonet or knife. With the Optional Rules, a soldier can carry a secondary weapon (pistols, for example), satchel charges, rocket launchers, extra ammunition, and other pieces of equipment. Fill in weapons data from the Weapons Chart. Leave the Physical Status Track blank (full strength).

10	9	8	7	6	5	4	3	2	1	0	DEAD
8	8	8	+1 8	+1 7	+2 7	+2 6	+2 6	+3 5	+3 4	None 0	

Troop Number 5 Primary Weapon Type: SMG MP

HG ○ ○ ○ ○ Dmg: 3L Short 1-17 Long 16-25

Other ● ● ● ● Secondary Weapon Type: Pistol MP

Ammo ● ● ● ● Dmg: 3L Short 1-7 Long 8-20



SEQUENCE OF PLAY

Following is a summary of the phases that constitute one turn in a game of **BattleTroops**. This is provided for quick reference by the players. The complete rules for each phase and segment are provided in the chapter devoted to that aspect of the game.

INITIATIVE PHASE

This phase happens only during the first turn of the game. One player from each side rolls 2D6. The side with the highest roll is designated Side A and moves all of its soldiers first. The losing side is Side B and moves its soldiers after Side A has finished.

MOVEMENT PHASE

1. Side A moves.
 - a. Remove Firing Arc counters from previous turn.
 - b. Move one soldier. If the soldier starts in or enters the firing arc of an enemy soldier, he may be fired on.
 - c. Set firing arc or throw hand grenade for soldier.
 - d. Repeat steps b and c until all soldiers on Side A have moved.
2. Explode hand grenades thrown by Side A and resolve area-effect attacks (Optional Rules only).
3. Side B moves.
 - a. Remove Firing Arc counters from previous turn.
 - b. Move one soldier. If the soldier starts in or enters the firing arc of an enemy soldier, he may be fired on.
 - c. Set firing arc or throw hand grenade for soldier.
 - d. Repeat steps b and c until all soldiers on Side B have moved.
5. Explode hand grenades thrown by Side B and resolve area-effects attacks (Optional Rules only).

END PHASE (OPTIONAL RULES ONLY)

1. Build up and dissipate heat for 'Mechs.
2. Make avoidance rolls for all 'Mechs.
3. Make recovery rolls for each unconscious MechWarrior.
4. Make morale roll for each squad.

There is no separate Combat Phase in **BattleTroops**. All combat occurs during the movement of individual soldiers. Combat is not considered to be simultaneous. Damage taken while moving is immediately applied and may stop further actions by that soldier for the remainder of the turn.



MOVEMENT

The map is overlaid with a pattern of dots, which regulate movement and determine range to targets. Each soldier must be placed on top of a dot.

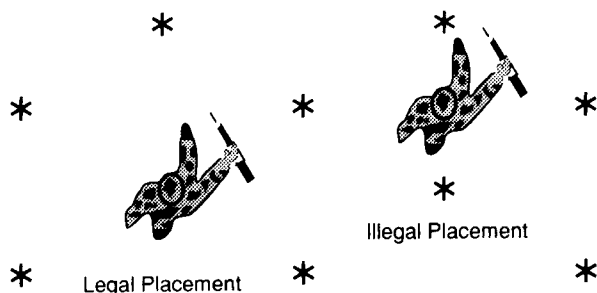

A soldier can move from any point to any adjacent point unless blocked by terrain.

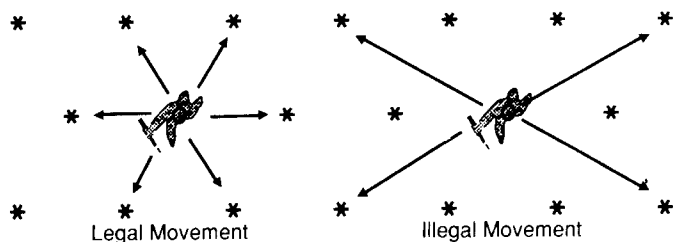

MOVEMENT POINTS

Movement Points are used to move a soldier from one dot to another, to set up a firing arc, to throw a grenade, and to perform various other special actions during a turn. A soldier may never perform an action that would exceed his Movement Point Allowance, nor may he save unused Movement Points for a later turn.

At full strength, each soldier has a Movement Point Allowance of 8 MP per turn. A soldier's MP Allowance may be reduced by wounds or other special events. See the **Damage** section of the rules for a detailed explanation.

MOVEMENT COSTS

Soldiers move from dot to dot by expending Movement Points. If he has sufficient MP, a soldier may move to any adjacent dot regardless of the facing of the figure.

To determine the MP cost to move to a new dot, the players should draw a direct line from the starting dot to the destination dot. If that line crosses a terrain feature, the players should consult the table below to find out the cost for the move. (See **Stairways** for exceptions.)

MOVEMENT POINT COST TABLE	
Terrain Type	MP Cost
Clear/No Terrain Feature	1
Undergrowth/Tree Branches	2
Contour Line	3
Door	2
Window	4
Furniture	2
Stairways*	+3 (If changing levels)
Walls	Impossible
Tree Trunk	Impossible
Special Actions	
Set Firing Arc	2, 4, or 6
Go Prone	1
Crawl	2x Terrain Cost
Stand Up	2
Prepare Grenade/Weapon	3
Throw Grenade	1 per dot thrown
Engage in Hand-to-Hand	7
Exchange Ammo/Weapon**	6
Set Up/Break Down Support Weapon**	4 per crew member
* See Stairways	
** Optional Rules	

For example, a soldier outside a building moves as shown on the diagram below. It costs 2 MP to travel through the door, 2 more MP to cross the furniture and a final MP to move to the clear dot. The total MP spent in movement was 5. This leaves 3 MP that can be used to set up a firing arc for the soldier.

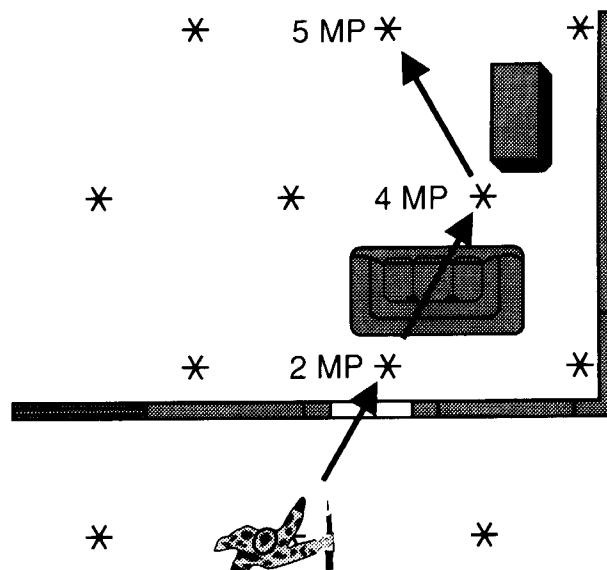

BATTLETROOPS

Certain terrain is impassible, such as walls or tree trunks. If the direct line of travel crosses any portion of such a terrain feature, the move is not allowed.

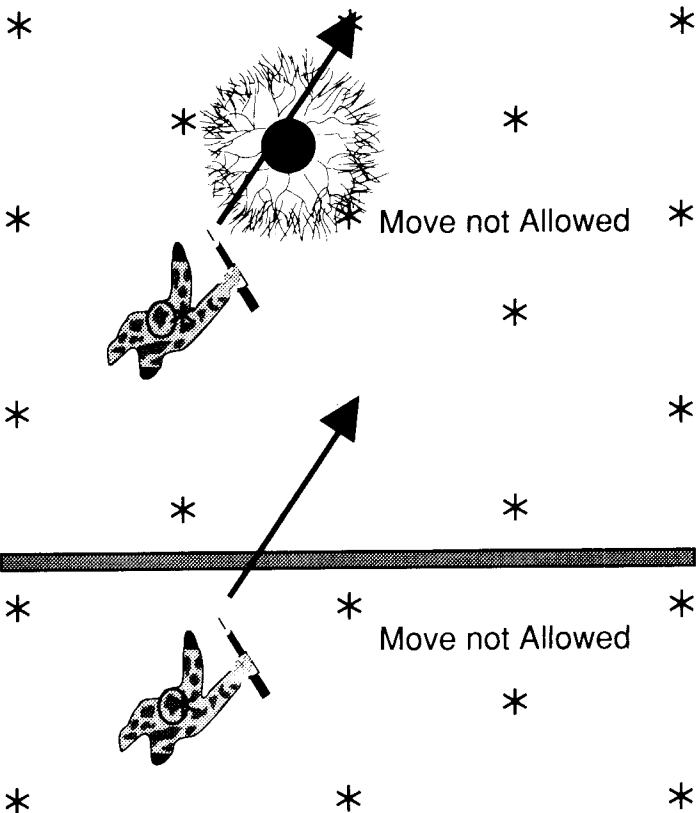

STAIRWAYS

Stairways are unique terrain features in that they fall on a dot rather than between the dots. Stairways are the only building feature that exists on all of the floors, basement, and roof of a building.

Soldiers use Stairways to go to a different elevation within a building. If a soldier enters a dot that has a Stairway, he may change one level for every 3 MP that he expends. A soldier is not required to change floors.

For example, the soldier below moves as indicated. When the soldier enters the Stairway, he can spend 3 MP to climb to the Second Floor or 6 MP to climb to the Third Floor. Thus at the end of his movement the soldier would have spent 2 MP to stay on the Ground Floor, 5 MP to be on the Second Floor, or 8 MP to be on the Third Floor.

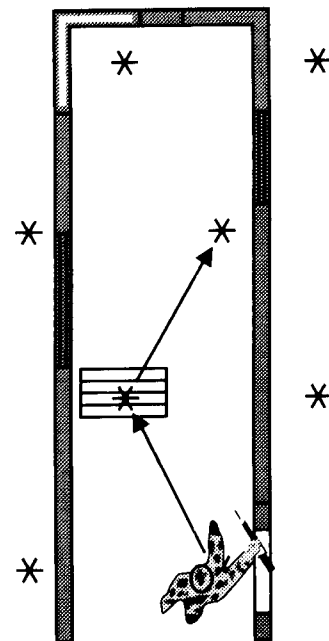

To indicate that a soldier is on a different floor, simply place the appropriate Floor counter next to the figure. Figures that do not have a Floor counter next to them are assumed to be on the Ground Floor.

PLACEMENT OF FIRING ARCS

After moving a soldier, the player may use any remaining MP to set up a firing arc for that trooper. There are three different size Firing Arcs counters. A soldier may select any of these if he has sufficient MP remaining.

The player places the arc under the figure facing any direction. The arcs have a white line in the center, which should point to an announced "center dot." This center dot is used to make sure the players agree on exactly where the arc is pointing. The center dot does not have to be adjacent to the soldier, it can be any dot on the map. It is permissible for the center line of a Firing Arc counter to point directly at a terrain feature that blocks the soldier's line-of-sight.

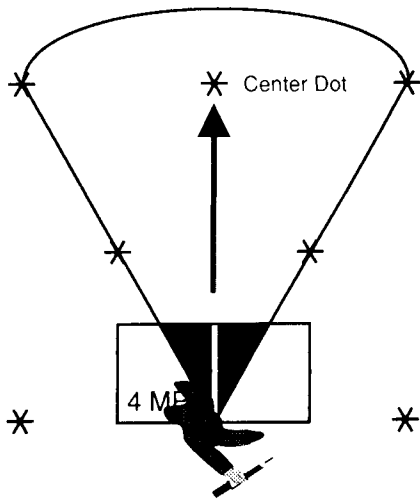

This Firing Arc serves as the facing of the soldier for the remainder of the turn. The soldier may fire on any enemy who enters that arc (see **Combat**).

For example, the soldier in the diagram below has spent 5 Movement Points to move into an office building. He has 3 MP left. The player would like to have a large Firing Arc, but this soldier only has enough MP left to purchase a 2 MP arc. The player does so, placing the arc on the map as indicated. This soldier may fire at any enemy who enters the arc.

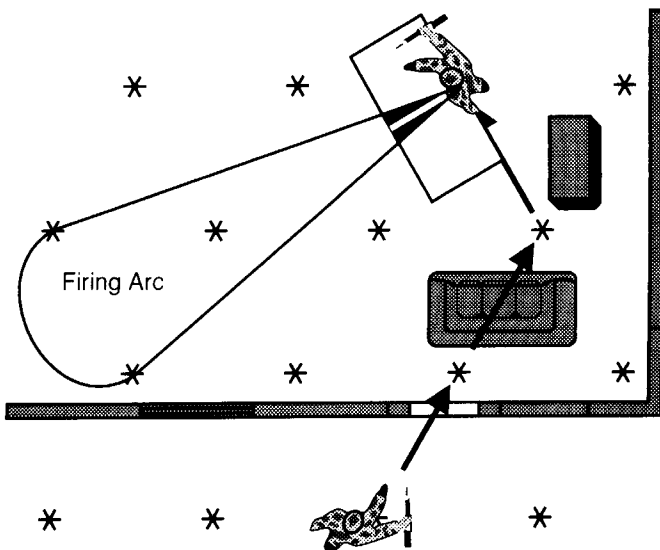

GOING PRONE

A soldier may go prone by expending 1 MP. A prone soldier may move (crawl), but the MP cost for all terrain is doubled. MP cost for placing a Firing Arc and other special actions stay the same.

Going prone gives the soldier defensive modifiers in clear terrain and changes partial cover to blocking terrain, though he may still crawl over the objects.

STANDING UP

Prone soldiers may stand up at any time by expending 2 MP. Once the soldier has stood up, he may move normally.

PREPARE WEAPON/GRENADE

By spending 3 MP, a soldier may prepare to throw a hand grenade or prepare another weapon for use. A soldier may have only one weapon prepared at a time. See **Hand Grenades** and **Special Weapons** for a more detailed explanation.

A soldier need not use a prepared weapon in the turn that he readies it. The weapon can be used in a subsequent turn. A prepared weapon is one that is ready for use. A weapon need not be prepared anew after each use, only when the soldier has prepared a different weapon instead. A soldier can be ready to use only one weapon at a time, and so preparing a different weapon means the previous one is no longer prepared.

THROW GRENADE

After his movement, a soldier may throw a prepared hand grenade by expending 1 MP per dot range to the target. See **Hand Grenades** for a more detailed explanation.

STACKING

No soldier may end his movement on the same dot as another soldier unless they occupy different floors of a building. A soldier may freely pass through another soldier.



COMBAT

In the basic game, all personal firearms are considered to be automatic or semi-automatic weapons. Personal weapons do not run out of ammunition, though a soldier may carry a limited number of grenades.

Combat takes place during the enemy Movement Phase. A soldier may fire on any enemy in his firing arc, either at the start of movement or during movement. The firing soldier must have a valid line-of-sight to his target and use a weapon with sufficient range to reach the enemy. Combat is resolved immediately, with all damage taking effect before the target completes movement.

Soldiers who do not move during a turn but start the turn in an enemy soldier's firing arc may be attacked after all other friendly units have completed their movement and before any grenades explode.

FIRING ARC

A Firing Arc counter defines the area that a soldier is scanning, looking for a target. The counter marks only the beginning of that arc, which extends out for the entire length of the mapsheet.

A soldier equipped with a semi-automatic weapon may fire only once per turn, but he may choose to withhold fire in the hope that his target will move into more exposed terrain or come closer. If a player passes up a shot in this manner, he may not force the other player to retrace the move. Once the soldier has fired, the Firing Arc should be removed. In cases where a soldier enters multiple enemy firing arcs at once, soldiers with semi-automatic weapons must announce their intention to fire before any combat is resolved.

A soldier armed with an SMG or other automatic weapon can engage the same target for each dot that he moves in the soldier's firing arc. For example, if a soldier charges straight down the firing arc of another soldier, the second soldier will get to fire at him once for each dot closer he moves. The Firing Arc counter stays in place throughout the turn, and the firing soldier may engage any other enemy troops who enter his arc during the turn.

In the diagram below, the soldier carrying an SMG may fire at the other moving soldier at each of the indicated locations. If the soldier had been equipped with a semi-automatic weapon, he would have been able to fire only once at any of the indicated locations.

LINE-OF-SIGHT

When a player wishes to fire on an enemy, he must first discover whether or not his soldier can see the target. Various terrain features can block line-of-sight, making a shot impossible.

Check the line-of-sight by laying a straight edge (a ruler or a sheet of paper) from the attacker's dot to the target dot. Any intervening terrain affects the line-of-sight. The players check for blocking terrain that is higher than both the attacker and his target, which would block LOS.

Soldiers, even when standing, do not add to the level of the dot they occupy. Buildings and trees, however, have a cumulative effect with terrain elevation. Trees add two levels to the height of the underlying terrain (Level 0 on the maps provided). Buildings add their elevation level to the underlying terrain.

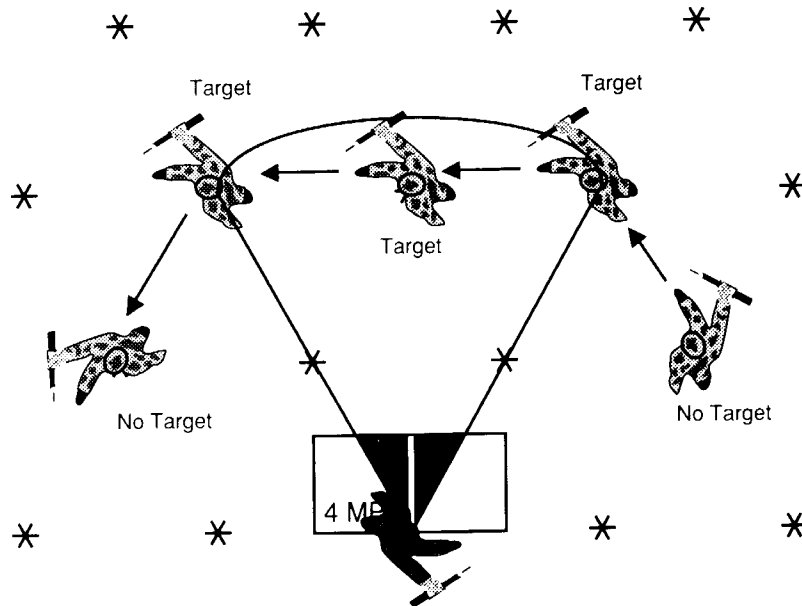

The line-of-sight may be blocked by walls, tree trunks, standing friendly or enemy troops, and contour lines. Remember that the roof of a building has no surrounding walls, doors, or windows.

It is possible to see through windows or doors into the interior of a building, again remembering that exterior doors do not extend above the ground floor and that basements have neither windows nor exterior doors. Floors function as walls to block line-of-sight to any interior dot (not adjacent to a window or door) on a different level of a building. Floors block line-of-sight between soldiers at different levels.

The only possible sighting between two soldiers on different floors of the same building occurs if both soldiers are in the same Stairway only one floor apart. For example, two soldiers are in the same Stairway, one on the Third Floor and the other on the Ground Floor. Neither can see the other. If one of the soldiers goes to the Second Floor, however, there is a valid LOS between them. If the other soldier has a Firing Arc counter placed, he may fire at the moving soldier.

Furniture or windows do not block LOS if both soldiers are standing. However, the LOS is blocked if one of the soldiers is prone behind a window or furniture. Soldiers on a roof have no walls to block LOS. LOS is blocked between a soldier in a basement and anyone outside the building.

TERRAIN ELEVATION DEAD ZONES

The Dead Zone directly behind or below the peak of an elevated area may also block line-of-sight. Only contour lines, walls, and tree trunks create Dead Zones. If either the attacker or target is adjacent to blocking terrain, line-of-sight determination depends on their relative elevations. A soldier adjacent to a tree occupies one of the four dots closest to its trunk. A soldier adjacent to a wall or contour line occupies a dot in the row of dots closest to the blocking terrain feature. In these cases, LOS is blocked unless one of the soldiers is at least one level higher than the intervening terrain.

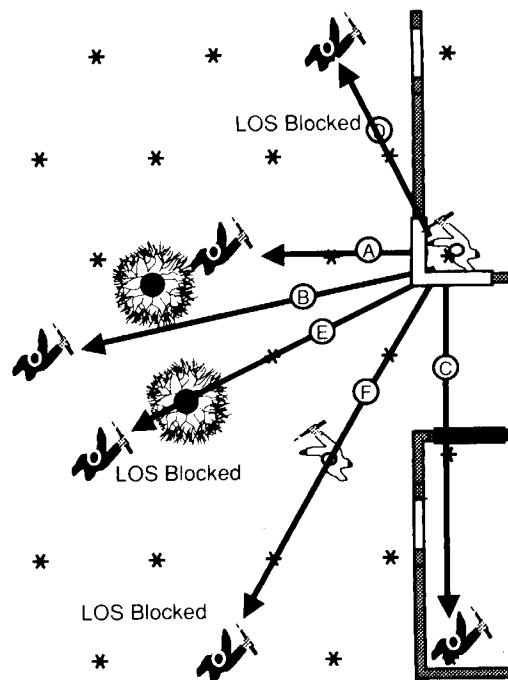

For example, the soldier in the building is standing in a window on the Ground Floor (Elevation 0). He has a valid line-of-sight to A, B, and C. The line-of-sight to D is blocked by the wall of the building; the LOS to E is blocked by the tree trunk; and the LOS to F is blocked by an upright soldier. If that soldier were prone, then the LOS to F would be valid. If the sighting soldier were prone behind the window, no LOS would be valid. If the sighting soldier were on the Third Floor (Elevation 2), all of the enemy soldiers would be seen except for C and E. E is in the Dead Zone for the tree trunk, which is two levels tall. This Dead Zone would be nullified if the sighting soldier were on the roof of the building. An LOS to C would cross through the floor in the building, thus blocking the attempt. However, if that soldier were standing at the window, the LOS would not be blocked because it would not pass through a floor.

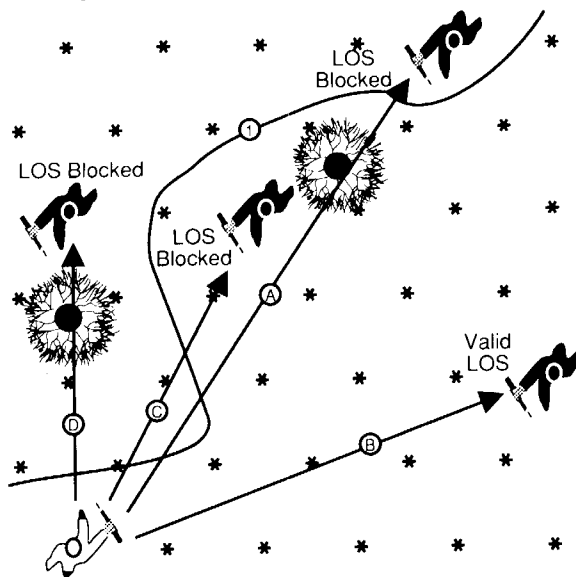

In the above diagram, the line-of-sight to B is valid. The LOS to A and D are blocked by tree trunks. The LOS to C is blocked because it crosses the Level 1 contour line and both soldiers are at Level 0.

RANGED COMBAT

Once a soldier has a valid line-of-sight to an enemy soldier in his firing arc, he may fire his readied weapon. If the soldier does not have a readied weapon, then he may not fire at the target. First calculate the Base To-Hit Number, and then apply any modifiers.

Determine the range by counting the number of dots from the firing soldier to his target. Begin at the dot next to the attacker along the line-of-sight, following the shortest path and counting the target's dot. More distant targets are generally harder to hit.

BASE TO-HIT NUMBER

The Base To-Hit Number depends on the range to the target. If the target falls within a weapon's Short Range, the Base To-Hit Number is 6. If the target is within a target's Long Range, the Base To-Hit Number is 8. A weapon may not fire at a target beyond its maximum range.

WEAPON TABLE

Weapon Type	Damage	Short Base 6	Long Base 8
Semi-Automatic Firearms:			
Pistol	3L	1 – 7	8 – 20
Rifle	4L	1 – 27	28 – 75
Laser Pistol	4L	1 – 12	13 – 30
Laser Rifle	5L	1 – 17	18 – 105
Gyrojet Rifle	6L	1 – 57	58 – 180
Automatic Firearms:			
Blazer	4L	1 – 17	18 – 105
Auto Pistol	2L	1 – 7	8 – 20
SMG	3L	1 – 15	16 – 25
Hand-to-Hand Weapons:			
Blackjack	5B	Adjacent	
Club	4B, 1L	Adjacent	
Stun Stick	8B	Adjacent	
Neural Whip	8B, 3L	Adjacent	
Bayonet/Knife	3L	Adjacent	
Sword	4L	Adjacent	
Vibro-Blade	5L	Adjacent	
Fists	(current MP/2)B	Adjacent	

L = Lethal Damage * B = Bruise Damage

Lethal Damage is capable of causing death immediately; Bruise Damage is not. See the **Damage** section of the rules for a detailed explanation.

TO-HIT MODIFIERS

The Base To-Hit Number is modified to account for terrain, shielding, and other factors. All applicable modifiers are cumulative, except where noted.

TO-HIT MODIFIERS

Terrain or Action	Modifier
Partial Cover	+1 per partial entered or crossed by LOS
Attacker Prone	-1
Target Prone (Range >1/ Range 1)	+1/-1

Partial Cover

The terrain between the attacker and target can reduce the accuracy of the shot. As noted in the terrain description section, all terrain features that are marked in gray (undergrowth, branches, windows, and portions of doors) provide partial cover. For each one of these terrain features that the LOS passes through, add 1 to the Base To-Hit Number.

Partial cover is ignored if either the attacker or target is higher than the terrain feature. For example, if two soldiers were both at an elevation of 1 and their LOS passed through some undergrowth on Ground Level, no modifier would be used. If the undergrowth were also at an elevation of 1, then the +1 modifier would be used for all attacks.

Branches of trees are considered to be two levels higher than the underlying terrain. All other partial cover is considered to be at the level of the underlying terrain. An attack is not modified by partial cover adjacent to the soldier firing, but it is modified by partial cover adjacent to the target.

Attacker's Condition

A soldier's physical condition has a large effect on his accuracy. The Record Sheet shows the progressively larger modifier for accumulated damage on the Physical Status Track. The largest applicable damage modifier is used. For example, if a soldier has taken damage in the 6 box, he would have a +2 modifier for any attacks that he makes.

Prone

If the target is prone and the attacker is more than one dot away, a +1 modifier is added to the Base To-Hit Number. If the attacker is prone, a -1 modifier is applied to the Base To-Hit Number. If the attacker is standing and firing at a prone target one dot away, a -1 is applied to the Base To-Hit Number.

HAND-TO-HAND COMBAT

Rather than attack an enemy with a firearm, a soldier may make a Hand-to-Hand attack against any adjacent enemy soldier with whom he has a valid LOS. Only Hand-to-Hand weapons may then be used by either soldier. A soldier must prepare a Hand-to-Hand weapon before using it in combat. Rifles are considered to have bayonets fixed on them at the beginning of the game and so do not need preparation prior to Hand-to-Hand Combat. If a soldier has another type of weapon prepared, he may use it as a club. Soldiers without a prepared weapon must use their fists.

A Hand-to-Hand attack takes 5 Movement Points and is announced during the attacker's Movement Phase, but it is resolved during the target's Movement Phase just like Ranged Combat. The target cannot move or engage in any activity until the Hand-to-Hand attack is resolved.

He may then declare his own Hand-to-Hand Combat, or he can move and take other actions after damage has been assessed. The Base To-Hit Number for Hand-To-Hand Combat is 4. The only To-Hit Modifier that affects Hand-to-Hand Combat is damage to the attacker.

RESOLVE ATTACK

Add all of the applicable modifiers to the Base To-Hit Number to obtain the Modified To-Hit Number. The attacker rolls 2D6. If the result equals or exceeds the Modified To-Hit Number, the attack succeeds. If the Modified To-Hit Number is greater than 12, no attack may be made.

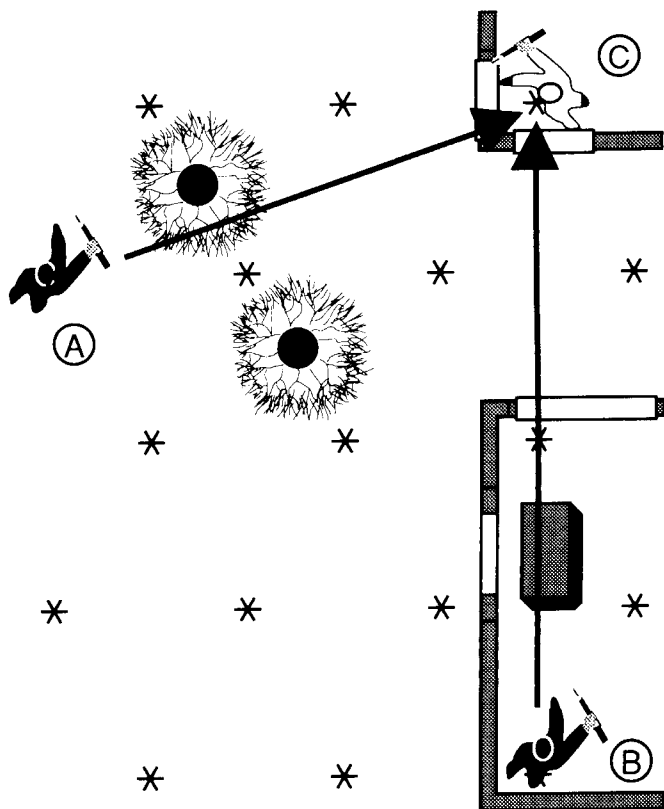

For example, the Davion soldier (C) moved into the firing arcs of two Kurita soldiers (A and B), as shown above. Both Kurita soldiers are armed with SMGs. The range in both cases is 4, and so the Base To-Hit Number is 6. Kurita soldier A has a Modified To-Hit Number of 6 + 1 or 7, because the adjacent branches do not affect his fire but he still must add one for the window. Kurita soldier B has a Modified To-Hit Number of 9 because his LOS crosses partial cover three times (the furniture, the window of his building, and the window of the Davion soldier's building). Note that the furniture modifies the attack because it is not adjacent to soldier B, contrasting with the branches in front of soldier A.

DAMAGE

When a soldier is hit, the attacking player rolls 2D6 for location. The result is the block where the damage starts. On a roll of 11 or 12, damage starts in Block Number 10.

Record the damage by crossing out the starting location box, like a strike in bowling, and then crossing out blocks to the right equal to the damage value of the weapon. Use an X to indicate Lethal Damage and a single slash for Bruise Damage.

For example, the Davion soldier in the above illustration was hit by the first Kurita soldier, and 12 was rolled for location. Three boxes are marked off, starting in Box 10. The Davion player makes the indicated changes on the soldier's Record Sheet.

10	9	8	7	6	5	4	3	2	1	0	DEAD
X	X	X	+1 8	+1 7	+2 7	+2 6	+2 6	+3 5	+3 4	None 0	
Troop Number _____		Primary Weapon Type: _____ MP _____									
HG ○○○○		Dmg: _____			Short _____			Long _____			
Other ○○○○		Secondary Weapon Type: _____ MP _____									
Ammo ○○○○		Dmg: _____			Short _____			Long _____			

If a wounded soldier is hit in an area that is already crossed out, the starting box should be shifted to the right to the first open box. Then the appropriate number of boxes should be crossed off, skipping any previously checked. After multiple hits, a soldier's Physical Status Track could have clusters of damaged and undamaged boxes.

For example, the Davion soldier has now been hit twice and has blocks 10, 9, 8, 5, 4, and 3 marked off. Another SMG hits the soldier, and a 12 is rolled. Damage would be taken in 7, 6, and 2.

10	9	8	7	6	5	4	3	2	1	0	DEAD
X	X	X	1 8	1 7	2 7	2 6	2 6	3 5	+3 4	None 0	
Troop Number _____		Primary Weapon Type: _____ MP _____									
HG ○○○○		Dmg: _____			Short _____			Long _____			
Other ○○○○		Secondary Weapon Type: _____ MP _____									
Ammo ○○○○		Dmg: _____			Short _____			Long _____			

Bruise Damage is recorded with a single slash as a spare in bowling. If subsequent Bruise Damage hits the same area, mark the slash in the opposite direction, converting it to Lethal Damage. Lethal Damage in the same area as previous Bruise Damage treats the block as clear.

Hand-to-Hand attacks with clubs or blades do the specified amount of both Bruise and Lethal Damage. In allocating damage, mark the Lethal Damage first, then the Bruise Damage. For example, a club does 1 point of Lethal and 4 points of Bruise Damage. The attacker rolls a 7 for location, thus the Lethal Damage will be in Box 7 and the Bruise Damage in Boxes 6, 5, 4, and 3.

10	9	8	7	6	5	4	3	2	1	0	DEAD
8	8	8	X	1 7	2 7	2 6	2 6	+3 5	+3 4	None 0	
Troop Number _____		Primary Weapon Type: _____ MP _____									
HG ○○○○		Dmg: _____			Short _____			Long _____			
Other ○○○○		Secondary Weapon Type: _____ MP _____									
Ammo ○○○○		Dmg: _____			Short _____			Long _____			

BATTLETROOPS

In a more involved example, a Steiner soldier has been hit by a Marik trooper who has been using his SMG as a club. The Steiner soldier has already been wounded, as seen below. The hit starts in Box 7. That area has already been damaged, and so the one point of Lethal Damage starts in Block 6, overlaying the previous Bruise Damage. The first point of Bruise Damage is in Block 5, converting that block to Lethal Damage. Blocks 4 and 3 are already struck out, so the second point of Bruise Damage goes to Block 2, making it Lethal Damage. Block 1 is now Bruised, and the final point of Bruise Damage is applied to Block 0, causing the soldier to fall unconscious (see **Damage Effects**).

10	9	8	7	6	5	4	3	2	1	0	DEAD
			1	2	2	2	3	+3	None		
8	8	8	X	X	X	X	X	X	X	X	

Troop Number _____ Primary Weapon Type: _____ MP _____

HG ○○○○ Dmg: _____ Short _____ Long _____

Other ○○○○ Secondary Weapon Type: _____ MP _____

Ammo ○○○○ Dmg: _____ Short _____ Long _____

DAMAGE EFFECTS

Wounds affect a soldier's abilities, mostly his movement and combat skills. Lethal Damage and Bruise Damage affect a soldier differently. Bruise Damage has no effect on movement and combat until Block 0 is struck and the soldier falls unconscious. Bruise Damage kills a soldier only when the Dead Block is struck a second time (changing the Bruise Damage to Lethal Damage).

A soldier's Movement Points and firing modifier are shown in the block immediately to the right of the lowest numbered block that has Lethal Damage. If Block 4 is marked off, for example, the soldier has the MP and firing modifier listed in the Block 3 (6 and +2).

Soldiers whose Movement Points fall below their current level immediately drop prone and end their movement. They may not expend any more Movement Points for the turn or set up a

firing arc. They immediately receive all prone bonuses and LOS restrictions because of the new position. This can cause another soldier to lose a valid LOS and not be able to shoot. It is important to decide which soldier will fire first at an enemy who enters multiple friendly firing arcs. Soldiers do not fall prone as the result of Hand-to-Hand Combat.

Note that a healthy soldier needs a hit location of Block 7 or less to fall prone. Hits in the 10 through 8 Blocks do not force a soldier to end his movement. The soldier does not drop prone and may continue his movement, but all attacks that he makes have a +1 modifier.

If the 1 Block has Lethal Damage, the soldier goes unconscious. Bruise Damage in the 0 Block also causes the soldier to go unconscious. Unconscious soldiers are out of the game (though they can recover for play in future battles). If the Dead Block has Lethal Damage, the soldier is out of the game and cannot recover for use in future games. Counters representing dead or unconscious soldiers should be removed from the mapsheet unless players are using the Optional Rule for Exchanging Weapons.

10	9	8	7	6	5	4	3	2	1	0	DEAD
			1	1	+2	2	2	+3	+3	None	
8	8	8	X	X	7	X	X	5	4	0	

Troop Number _____ Primary Weapon Type: _____ MP _____

HG ○○○○ Dmg: _____ Short _____ Long _____

Other ○○○○ Secondary Weapon Type: _____ MP _____

Ammo ○○○○ Dmg: _____ Short _____ Long _____

For example, this soldier has taken Lethal Damage in the 7, 6, and 4 Blocks, and Bruise Damage in the 3 Block. This soldier will use the modifiers in the 3 Block for all future actions.



SPECIAL WEAPONS AND EQUIPMENT

HAND GRENADES

Soldiers start the game with a limited number of hand grenades, normally four. Once he has thrown all of his grenades, a soldier may not throw any more (for an exception, see the Optional Rule for **Exchanging Weapons**).

Any standing soldier can throw a prepared hand grenade at the end of his Movement Phase and after all enemy direct fire has been resolved against him. The grenade can be thrown a maximum of 8 dots, as long as the thrower has a valid LOS and sufficient MP. Terrain features that give partial cover never block LOS for throwing a hand grenade.

It costs 1 MP to throw a grenade for each point of range. Costs to throw a hand grenade are doubled for prone soldiers. The Base To-Hit Number is also equal to the range to the target dot, and it is modified normally by partial cover, windows, undergrowth, branches, and so on. Again, partial cover adjacent to the thrower does not modify the throw.

If the attacker misses his To-Hit Number, the hand grenade falls nearby according to a scatter procedure. If the throw was through partial cover, the grenade scatters from the dot nearest that terrain feature following the LOS back toward the thrower. Thus if a throw was to go into a building through a window, the grenade scatters from the dot immediately outside the window, not from inside of the building. If the throw does not pass through any partial cover, the grenade scatters from the target dot. Having located the scatter dot, the attacker rolls one die to determine the direction of the scatter as indicated by the scatter diagram on the map and a second die to determine how many dots distant the grenade lands.

A grenade cannot scatter through a wall, tree trunk, or other impassible terrain. If the scatter procedure takes a grenade through such terrain, place the grenade on the last dot before reaching the blocking terrain. It can scatter through a door, window, undergrowth, Stairway, or branches. If the grenade ends up in a Stairway, it falls to the next floor before exploding. Grenades that scatter outdoors are assumed to explode at Ground Level.

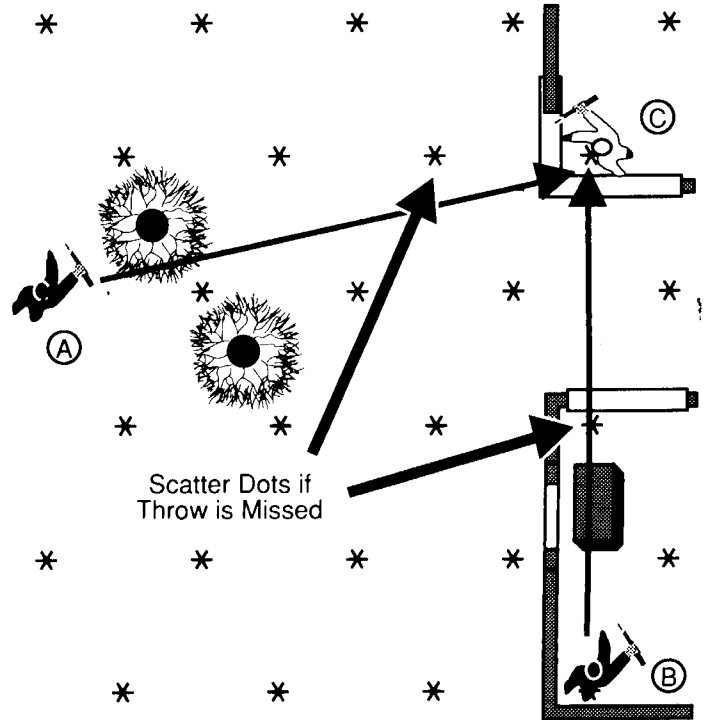

For example, Kurita soldier A moves 1 dot to his current location, prepares a grenade for 3 MP, and expends 4 MP to throw it a distance of 4 at Davion soldier C in the window. The Modified To-Hit Number is 4 (the range), plus 1 for the window, for a total of 5. There is no modifier for the tree branches because the soldier is adjacent to them. Kurita soldier A needs a 5 or higher to throw the grenade where he wants it. If he misses, the grenade scatters from the dot in front of the window.

Kurita soldier B also moves and expends 4 MP to throw a grenade at a distance of 4. His Modified To-Hit Number is 7 (4 for range, 1 for furniture, and 2 for the two windows). If he misses, the grenade scatters from the dot shown. This is a risky throw because if it fails, the grenade will not scatter through any of the walls of the building.

Grenades may be throw up or down a Stairway. A soldier can throw a grenade up or down only one level, and his target dot must be the Stairway dot. The throwing soldier must be in or adjacent to the Stairway to throw the grenade up a level. To throw down the Stairway, the soldier needs only a valid LOS to the Stairway dot.



GRENADE DAMAGE

Grenades explode after all friendly troops have moved and before the enemy Movement Phase. A grenade causes 6 points of Lethal Damage to the soldier on the blast dot. It causes 3 points of Lethal Damage to soldiers within 1 dot, and 1 point of Lethal Damage to soldiers within 2 dots.

Only soldiers with valid LOS to the blast dot are subject to damage. For LOS purposes, treat the grenade as a prone attacker. Thus windows and furniture block a grenade's blast; undergrowth and branches do not.

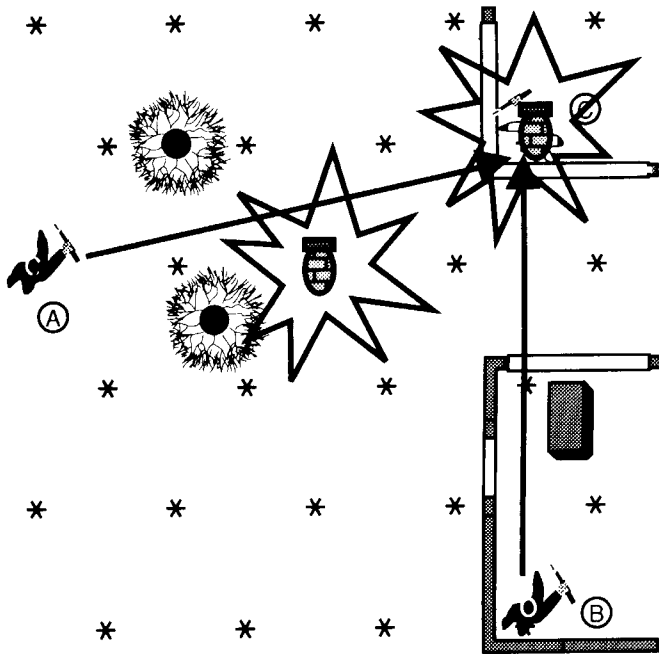

For example, the two Kurita soldiers throw grenades, which end up as shown. The one that explodes inside the building gives 6 points of Lethal Damage to Davion soldier C. The window stops the blast (the "attacker" is prone), and so anyone outside of the building would be safe.

The second Kurita grenade thrown by A misses, scattering in direction 6 for 1 dot. It explodes as shown. This grenade does no damage to the Davion soldier inside (again the "attacker" is prone), but it is now 2 dots away from Kurita soldier A. This soldier sustains 1 point of Lethal Damage.

A grenade that explodes in a Stairway causes 3 points of Lethal Damage to anyone in the Stairway one level above or below the exploding grenade.

If a soldier is wounded by a grenade so that he must drop prone, that soldier cannot perform any actions during his next Movement Phase.

ARMOR

Most regular troops in the Inner Sphere wear some form of body armor. Though useless against the weapons mounted on 'Mechs, body armor significantly reduces the damage caused by shrapnel and small-arms fire.

If allowed by the scenario, a player can equip his men with various types of body armor. Body armor is rated by Armor Points, with each point of armor allocated on a soldier's Record Sheet by circling blocks on the Physical Status Track. Circled boxes can start anywhere on the track but must be consecutive.

For example, if a soldier is wearing a Flak Body Suit, he gets 4 points of armor. He simply circles four consecutive damage numbers on his record sheet (4,3,2,1) or (10,9,8,7) and so forth.

If an armored block is hit by Lethal Damage, the soldier records Bruise Damage instead. The next Lethal Damage to this area completes the X. If an armored block is hit by Bruise Damage, make no mark. An armored area absorbs unlimited Bruise Damage.

Armor does reduce the number of Movement Points available to the soldier as indicated on the Armor Table. Thus the soldier with the Flak Body Suit in the example would have only 6 MP instead of 8.

ARMOR TABLE

Helmet (Assumed and taken into account)		
Flak Vest	2 Blocks	-1 MP
Flak Body Suit	4 Blocks	-2 MP
Combat Armor (Full Suit)	6 Blocks	-3 MP

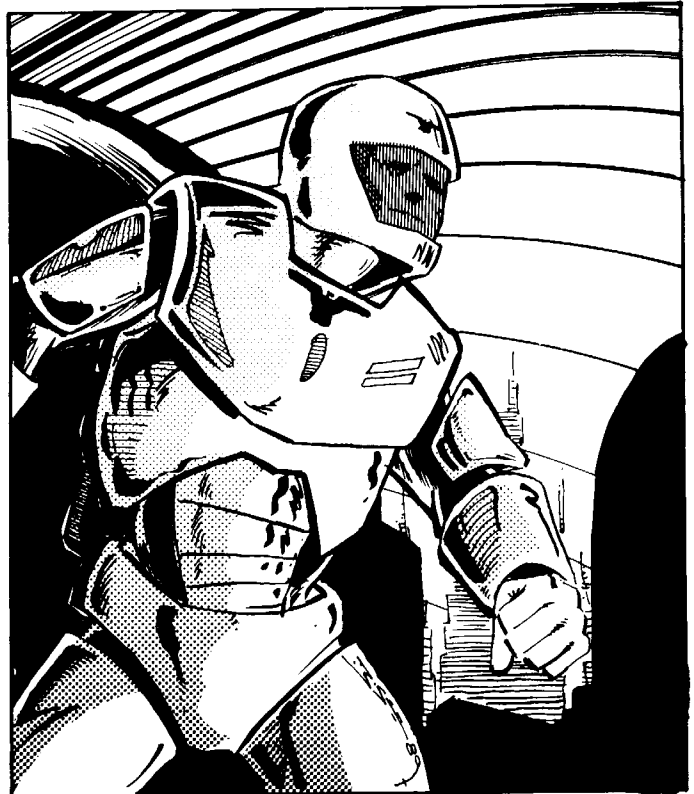



OPTIONAL RULES

Rules in this section can add realism or variety to **Battle-Troops**, but sometimes do so by making the game longer or more complicated. Players should feel free to use some, all, or none of these rules.

WEAPONS

When using some Optional Rules, a soldier might carry a weapon that has limited ammunition. Rather than having the soldier completely unarmed after expending his ammunition, he can carry a secondary weapon.

Only pistols, laser pistols (not auto pistols), Light Anti-Tank Weapons (LAW), ammunition reloads and Hand-to-Hand weapons may be carried as secondary weapons. It costs 3 MP to draw and prepare a secondary weapon. A soldier is always considered to be equipped with a knife/bayonet in addition to his primary and secondary weapons.

Rather than carry a secondary weapon, a soldier can carry additional ammunition for any area-effect weapon. Forgoing a secondary weapon gives a soldier double the normal ammunition, but a soldier may never carry more than four hand grenades.

EXCHANGING WEAPONS/AMMO

Friendly soldiers who are adjacent to one another and have no blocking terrain between them can exchange weapons, hand grenades, or ammunition. Only one weapon or up to four hand grenades or other type of ammunition can be transferred. A soldier cannot carry more weapons, hand grenades, or ammo than he could at the start of the game. A soldier can drop an item



at no cost. A dropped item remains in the location and can be picked up by any soldier, friendly or hostile, who is on that dot or adjacent to it.

The receiving soldier needs to use the 6 MP to get equipment from another soldier. If two friendly soldiers were adjacent to one another, one soldier could spend 6 MP to get the other's primary weapon or hand grenades. The other soldier might then spend 6 MP and take the first soldier's primary weapon.

If using these rules, the players should mark the location of dead and unconscious soldiers. The bodies do not affect movement or combat, but other soldiers can pick up their equipment.

AREA-EFFECT WEAPONS

In the basic rules, soldiers carry weapons that fire non-explosive projectiles. Many infantrymen in the Inner Sphere carry weapons that fire High Explosive shells to inflict damage over a wide area.

The phasing player fires area-effect weapons after movement, like a grenade. A soldier who fires an area-effect weapon may not set up a Firing Arc even if he has sufficient MP remaining to do so.

The MP cost for firing each area-effect weapon is shown on the chart below. Soldiers with insufficient MP left after movement may not fire the weapon that turn. Wounded soldiers who do not have sufficient MP to fire the weapon may not use that weapon.

A soldier can fire an area-effect weapon in any direction as long as he has a valid line-of-sight. Area-effect weapons use all range, line-of-sight, and To-Hit Modifier rules except those for prone targets.

An area-effect weapon may be fired only once a turn, even if the soldier has sufficient MP to fire it again in a single turn.

If the attacker's roll equals or exceeds the Modified To-Hit Number, the shell hits the targeted dot. If the roll is lower than the Modified To-Hit Number, the projectile misses its target. To find the impact dot, use the grenade scatter rules, except that the distance of the scatter is always one.

Once the actual impact dot is determined, place an appropriate HE Impact counter on the dot. The damage caused by area-effect weapons is assessed in a manner similar to grenade damage. Each weapon is rated for the damage that it does on the impact dot, at a range of 1, range of 2, and so forth, as shown on the Area-Effect Weapon Table.

Like a grenade explosion, the blast of an area-effect weapon in a Stairway affects a soldier one flight up or down in the Stairway as if he were one dot away from the explosion.

Ammunition for area-effect weapons is limited, as shown on the chart below. Keep track of the weapon's ammunition on the Other Ammo track of the Record Sheet. Once a weapon has expended its ammunition, it may no longer fire, but a soldier may carry double the weapon's load of ammo instead of carrying a secondary weapon. See also the rules section for each type of area-effect weapon.

AREA-EFFECT WEAPON TABLE

Weapon Type	Damage*	MP to Fire	Ammo	Short Base 6	Long Base 8
SRM	8/4/2 L	5	2	1 - 44	45 - 108
Heavy SRM	13/6/3/1 L	5	1	1 - 54	55 - 96
LAW	7/3/1L	4	1	1 - 22	23 - 80
Grenade Launcher	4/2/1L	3	4	1 - 10	11 - 24
Auto Grenade Launcher	3/2/1L	4	4	1 - 22	23 - 50
Light Recoilless Rifle	4/2/1L	4	2	1 - 36	37 - 70
Satchel Charge	10/5/2L	3	1	NA	NA
Flamer	2/1L	2	unlimited	1 - 6	7 - 12
Heavy Flamer	2/2/1L	4	4	1 - 6	7 - 12
Inferno	4/2/1L	5	2	1 - 44	45 - 108

*Impact dot/Range 1/Range 2/Range 3

Short Range Missiles

Short Range Missile Launchers are shoulder-fired versions of the BattleMech SRM. Their use follows all of the rules given in the **Area-Effect Weapons** section.

Grenade Launchers

Grenade Launchers are semi-automatic weapons that can be attached under the barrel of a rifle or SMG, though they can also stand alone. If a soldier has a Rifle/Grenade Launcher or SMG/Grenade Launcher combination, he may not have a secondary weapon.

The soldier may fire the Grenade Launcher rather than his primary weapon without preparing the Grenade Launcher separately. A soldier may not fire his primary weapon (set a Firing Arc) if he has fired the Grenade Launcher that turn.

Automatic Grenade Launcher

The Automatic Grenade Launcher is a hand-held, fully automatic grenade-launching system. It fires a burst of small explosive projectiles into a target area. Its use follows all of the rules given in the **Area-Effect Weapons** section.

Light Anti-Tank Weapon

The single-shot, disposable Light Anti-Tank Weapon is carried as a secondary weapon. Its use and function are similar to a portable rocket launcher.

Light Recoilless Rifle

The Light Recoilless Rifle is a bazooka-like weapon that offers an infantry unit accurate long-range fire. Making this version of the Recoilless Rifle light enough to be used by one soldier has also robbed it of much of its destructive power.

Satchel Charge

Satchel Charges are canvas sacks stuffed with plastic explosive. Special troops use these charges to disable 'Mechs and vehicles. The special rules describing their use in this manner are found in the **BattleTech Integration** section.

Satchel Charges may also be used as anti-personnel weapons in a manner similar to a hand grenade. The charge can be thrown at a cost of 2 MP per dot, or it can be placed on his own dot at the beginning or end of movement. If the charge is thrown, the player should determine if the Satchel Charge hits its target. The Base To-Hit Number is equal to twice the range to the target dot, and normal modifiers apply.

If the player misses his target, the Satchel Charge scatters in the same manner as other area-effect weapons, one dot in a random direction.

Flamers and Infernos

Flamers and Infernos follow all normal rules for area-effect weapons, and in addition, the player should put a Flames counter on the impact dot and all of the dots subject to blast damage. Adjacent dots separated from the impact dot by a window, tree trunk, or a wall do not catch fire. If the impact dot is in a Stairway, that Stairway is aflame at the levels above and below the point of impact.

See the **Fire** rules for a detailed explanation of the effects of fire. In addition to these effects, see the BattleTech Integration rules for using these weapons against 'Mechs or vehicles.

SUPPORT WEAPONS

Support weapons are mounted on a bipod or tripod and can deliver a deadly volume of fire. Their main disadvantage is their lack of mobility. Two or more soldiers are needed to move most support weapons.

Only the soldier designated as the operator of the weapon needs to list the support weapon as his primary weapon. The other crewmen can carry a normal load of primary and secondary weapons.

Each support weapon has a Crew Rating. This is the number of additional soldiers who must be adjacent to the weapon's operator in order to break down or set up the weapon, before it can be moved. If too few soldiers are present, the weapon cannot be broken down or set up. Note that some weapons have a Crew Rating of 0, meaning only a single operator is needed. It costs 4 MP for each crewman and the operator to break down any support weapon.

A crewman can move adjacent to the operator, use his 4 MP on the weapon, and continue to move. The operator cannot move until each of the other crewmen has spent his 4 MP to break down his portion of the weapon. Once the breakdown procedure has started, the weapon may not be fired.

Once the weapon is broken down, the operator and crewmen can move as normal. They need not stay together while moving, but they cannot fire other weapons while carrying the support weapon and the same crewmen must reunite to set up the weapon again.

Reverse the process to set up the weapon. Once all of the crewmen who helped to break down the weapon and the operator have come into position adjacent to each other and have used 4 MP each, the operator can fire the weapon, and thus the player can place a Firing Arc counter.

SUPPORT WEAPONS

Weapon Type	Crew	Damage	APV*	Short Base 6	Long Base 8
Light MG	0	5L	1	1 – 30	31 – 84
Medium MG	1	6L	1	1 – 30	31 – 84
Heavy MG	2	7L	2	1 – 36	37 – 110
Semi-Portable Laser	1	11L	1	1 – 80	81 – 240
Heavy Semi-Portable Laser	2	14.L	2	1 – 100	101 – 280
Man-Pack PPC	0	8L	1	1 – 50	51 – 110

*Armor Piercing Value, see **BattleTech Integration** Section for explanation.

Support weapons use only a 4 MP Firing Arc. To change direction of the arc, the player needs to set up the weapon again.

If the operator of a support weapon is killed, another soldier can replace him by performing an Exchange Weapon special action in that dot. A crewman can be replaced by any other soldier, with an Exchange Weapon action needed only if the support weapon was broken down and being carried.

JUMP TROOPS

Jump Troops are normal infantry equipped with jet packs that give them a limited flight ability. The jump equipment encumbers the troopers when they are grounded, and thus they move slowly on the ground but can fly quickly over longer distances.

A Jump Pack reduces a soldier's Movement Point Allowance by 2. Thus an unarmored, jump-equipped soldier has a total of 6 MP each turn. A Jump Trooper wearing Combat Armor gets only 3 MP to spend each turn.

Rather than spending MP to move, a jump-equipped soldier can activate his pack and fly. A soldier can use 3 MP to activate his pack and move between 6 and 16 dots, ignoring all terrain. If wounds or the encumbrance of body armor reduce a soldier's MP below 3, he cannot operate the Jump Pack.

The Jump Pack cannot be used to fly distances of less than 6 dots, and it may be activated only once per turn. A soldier can jump 16 spaces, land, and set up a 2 MP Firing Arc all in one turn, using 5 of his total of 6 available Movement Points). Jump Troops must land at the end of the turn.

Jump Packs cannot be activated inside a building. However, a jump jet trooper can step through a window, or off a roof, and then activate his pack.

During a jump, a soldier is assumed to be one level higher than the dot he is passing over. If the soldier enters an enemy's firing arc during flight, he is subject to fire but with a +2 modifier. If a jumping soldier takes damage that lowers his MP, the soldier must immediately land and fall prone. He may not expend more MP for that turn. If the damage causes the soldier to lose consciousness, he takes an additional 5 points of Lethal Damage from the fall.

The Jump Trooper may not fire while flying, but he can drop a hand grenade that he prepared before flight. The grenade may be dropped on any dot that he passes over, with the base To-Hit Number 8. If the attack misses, follow normal scatter procedure. It costs 1 MP to drop the grenade. Note that this cost precludes a Jump Trooper from preparing a grenade, jumping, and dropping the grenade all in one turn.

To put on or remove a Jump Pack costs 5 Movement Points. Any adjacent soldier can expend the 5 MP for a soldier who does not have sufficient MP to do it himself. Thus, to take a Jump Pack from a dead soldier, another soldier would first expend 5 MP to take it off the corpse, then spend 6 MP to take it, per the **Exchange Weapons** rule, and finally use 5 MP more to put it on himself.

LEADERSHIP

More than any other branch of the military, foot soldiers are affected by the judgment and courage of their leaders. History is full of examples of small groups of soldiers who performed seemingly impossible deeds under the direction of a charismatic leader. These factors can be simulated in **BattleTroops** by using the **Experience Level**, **Morale**, and **Leadership** rules.

EXPERIENCE LEVEL

The overall experience of an infantry squad is rated by the terms Green, Regular, Veteran, and Elite. Most infantry squads are rated as Regular. Though seasoned enough to avoid losing battles through the lack of discipline or skill, Regular troops are not experienced enough to win battles solely by those attributes. Squads are rated individually, and it is possible for two squads of the same platoon to have different levels of experience.

The squad's Experience Level rating affects the numbers of Movement Points each soldier can expend during a turn, per the chart below.

EXPERIENCE EFFECTS TABLE	
Experience Level	MP Bonus
Green	-1
Regular	0
Veteran	+1
Elite	+2

Regardless of a soldier's MP bonus, he cannot spend more than 8 MP a turn for movement, including falling prone, standing up, crawling, and going up or down stairs. Thus, an elite soldier has a total of 10 MP but can use only 8 of them on movement. The remaining two points can be used to set a Firing Arc, throw a prepared grenade, fire an area-effect weapon, or perform some other action that is not movement. Green troops have a maximum of 7 MP.

MORALE

A squad of soldiers will rarely fight until the last man is killed. At some point in the battle, an individual will decide that his life is more important than the mission given to the squad.

Roll for morale when four or more members of a squad are killed or knocked unconscious. If the roll is below the listed number, the squad breaks, and its remaining members attempt to flee off the board. Morale is rolled for during the End Phase of the turn. An additional roll must be made in each turn another member of the squad is killed or knocked unconscious. A single roll is made for the entire squad. Individual soldiers do not roll for morale.

BREAKING TABLE

Experience Level	Break Number
Green	9
Regular	7
Veteran	5
Elite	2

Modifiers

Each Additional Loss	+1
Opposing Force Has 'Mech	+1
Squad Leader	-1 per Leadership Skill Level

For each additional loss beyond four, one is added to the normal Break Number. If the opposing force has a functioning 'Mech, the Break Number is increased by one. Finally the Leadership rating of the squad's designated leader is subtracted from the Break Number, if the leader is conscious.

Members of a squad with broken morale may not expend MP to fire weapons or set firing arcs. Support weapons are abandoned, and the player controlling the broken squad must attempt to move the soldiers of that squad off the board.

LEADERS

Each squad should designate a Squad Leader. Unless otherwise noted in the scenario, each Squad Leader has a *Leadership* Skill Rating of 2. This Skill Rating is subtracted from the squad's Break Number when making morale rolls. This modifier cannot be used if the Squad Leader is unconscious or dead.

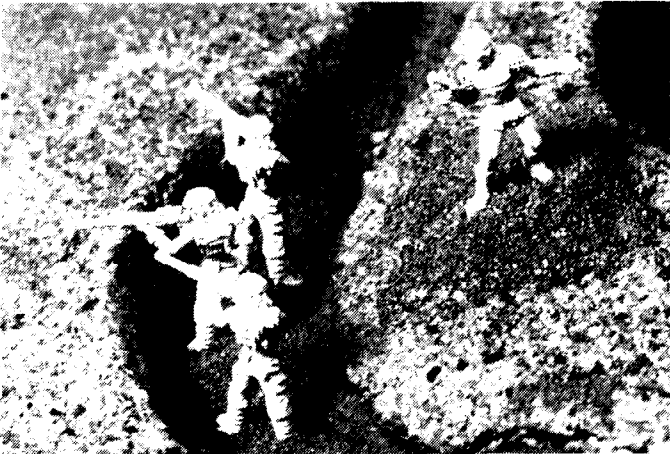

MECHWARRIOR INTEGRATION

MechWarrior characters can be used in **BattleTroops** with little modification, but they must be assigned to a squad.

Use the standard **MechWarrior** Character Record Sheet to keep track of damage and other items. The **MechWarrior** is not subject to the equipment limitations in **BattleTroops**.

All **MechWarrior** characters get 8 MP each turn. A character also gets MP equal to his *Running* Skill to use for non-movement actions.

Unless stated otherwise, **MechWarrior** characters operate under the same rules as **BattleTroops** characters. **MechWarrior** characters move and fire in the same manner as **BattleTroops** soldiers except that the **MechWarrior** character has additional modifiers to his Base To-Hit Number based on his *Weapon* Skill level. For each skill level above 1 the character has in the appropriate weapon, reduce his Modified To-Hit Number by 1.

For example, a **MechWarrior** character with a *Rifle* Skill of 3 applies a -2 modifier to the Base To-Hit Number when firing a Rifle Skill Class weapon. If the character were using a SMG at short range, the Modified To-Hit Number would be 6 minus 2, or 4.

Damage done by a **MechWarrior** character to a **BattleTroops** soldier is applied as detailed in **BattleTroops**. When a **MechWarrior** character is hit, resolve damage per the rules on Pages 81 through 86 of **MechWarrior**. The weapons do damage as listed on Page 76 of **MechWarrior** or in **Technical Readout 3026**. As an alternative, players can simply roll 1D6 for each point of **BattleTroops** Lethal Damage done. For example, a light machine gun hit would do 5D worth of **MechWarrior** damage. Damage is reduced by armor per the rules on Page 80 of **MechWarrior**.

Consciousness rolls and other effects are resolved as per **MechWarrior**. Damage to arms, blurred vision, fingers, and other critical hits listed on Pages 84 and 85 of **MechWarrior** translate directly to **BattleTroops**.

Leg damage is resolved per Page 84 of **MechWarrior** rules. Reduced movement leaves the character only 4 MP per turn rather than 8 MP.

If the **MechWarrior** character is designated as the unit's leader, the player may subtract 1 from his initiative roll for each level of skill in *Tactics*.

If the **MechWarrior** is a Squad Leader, the squad receives a -1 on morale checks for each level of *Leadership* that the character has, as long as the character is conscious.

WEAPON CONVERSION

BattleTroops provides statistics for all personal weapons described in **MechWarrior**, but it does not convert all of the **MechWarrior** weapons listed in **Technical Readout 3026**. Players who want to use these weapons should use the following guidelines to convert them to **BattleTroops** values.

To convert Support Weapons to **BattleTroops**, subtract one from the Crew Needed to obtain the **BattleTroops** Crew Rating.

To convert damage for semi-automatic weapons, start with the number of dice of **MechWarrior** damage, add 1 for every three points of additional damage (or fraction thereof), and add an additional 1 to obtain **BattleTroops** damage. So a Magna Laser Rifle, which does 4D6+2 points of **MechWarrior** damage, does 4 +1+1, or 6, points of **BattleTroops** Lethal Damage.

Calculate damage for automatic weapons, those that use the SMG rules, in the same manner, except do not add the final plus 1. A Pulse Laser Rifle, which does 3D6+2 points of damage in **MechWarrior** terms, does 3 +1, or 4, points of Lethal Damage in **BattleTroops**.

Calculate the damage for area-effect weapons in the same manner as a semi-automatic weapon. Reduce the damage by half for each dot away from the impact location, dropping fractions. Thus, a Portable Rocket Launcher does 4D6+6 points of **MechWarrior** damage or 7L/3L/1L in **BattleTroops**.

BattleTroop ranges for all weapons are double the **MechWarrior** listing. Split the **MechWarrior** Medium Range bracket evenly between the **BattleTroops** Short and Long Range brackets. Thus, a Portable Rocket Launcher has a **MechWarrior** listing of Short: 1 – 6, Medium: 7 – 16, and Long: 17 – 36. This converts to **BattleTroops** ranges of Short: 1 – 21 and Long: 22 – 72.

The MP cost to fire any **MechWarrior** area-effect weapon is 5. If the weapon is listed as a one-shot weapon, the Ammo Rating is one. The Ammo Rating for other weapons is 2.

Use the Damage Column of the Support Weapons Table on Page 127 of **Technical Readout 3026** to determine the APV of any Support Weapon.

BATTLETECH/CITYTECH INTEGRATION

The instrument of decision in the Inner Sphere is the Battle-Mech. These monstrous vehicles are faster, more maneuverable, better armored, and more heavily armed than any other weapon.

Players who also own FASA's **BattleTech** or **CityTech** may use the 'Mechs in their **BattleTroops** games.

FILLING OUT THE 'MECH RECORD SHEET

If the scenario calls for the use of a 'Mech, the players should use an appropriate 'Mech Record Sheet, but make the following changes to reflect the different scale.

To convert a 'Mech's walking, jumping, and running speeds to **BattleTroops**, multiply by five. A 'Mech that can move 4/6 in **BattleTech** can move 20/30 in **BattleTroops**.

The damage and range for 'Mechs' weapons should be converted using the following table. All **BattleTech** ranges are multiplied by 12.

Weapon Type	Damage	Range		MP to Fire
		Minimum	Maximum	
Semi-Automatic				
Small Laser	12L	–	36	–
Medium Laser	20L	–	108	–
Large Laser	32L	–	180	–
PPC	40L	36	216	–
Automatic				
Machine Gun	8L	–	36	–
Area-Effect:				
AC 2	8L/4L/2L	28	288	5
AC 5	20L/10L/5L/2L	36	216	5
AC 10	40L/20L/10L/5L/2L	–	180	5
AC 20	80L/40L/20L/10L/5L/2L	–	108	5
LRM 5	20L/10L/5L/2L	72	252	5
LRM 10	40L/20L/10L/5L/2L	72	252	5
LRM 15	60L/30L/15L/7L/3L/1L	72	252	5
LRM 20	80L/40L/20L/10L/5L/2L	72	252	5
SRM 2	16L/8L/4L/2L	–	108	5
SRM 4	32L/16L/8L/4L/2L	–	108	5
SRM 6	48L/24L/12L/6L/3L/1L	–	108	5
Flamer*	8L/4L/2L	–	36	5

*See **Flamer** Rules

In most cases, the Maximum Range of a 'Mech weapon far exceeds the size of the board and can be assumed to be infinite for the purposes of a **BattleTroops** encounter.

MOVEMENT

A 'Mech is represented on the **BattleTroops** map by a 4" round template. The template includes the 'Mech's firing arcs. Four die-cut triangles and a center cut are used to represent the 'Mech's movement and facing and the location of the 'Mech's feet. The circle also shows the 'Mech's "Dead Zone," the area it cannot target because it is too close to its body.

Unless otherwise stated, all **BattleTech** movement rules are in effect. In cases where **BattleTech** calls for MP expenditures to perform some actions, such as standing up, simply multiply the listed **BattleTech** MP cost by 5 to convert to the **BattleTroops** cost.

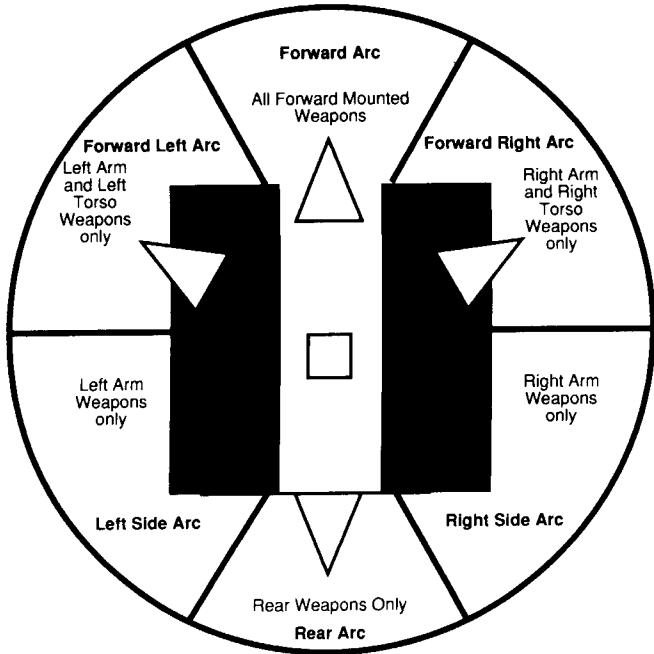

Unlike soldiers, a 'Mech has a definite facing that influences its movement, firing arcs, and the way it takes damage in combat. The template covers a number of dots when placed on the map.

The template must be aligned so there is a dot visible in the center and in each of the four triangular areas, as shown below.

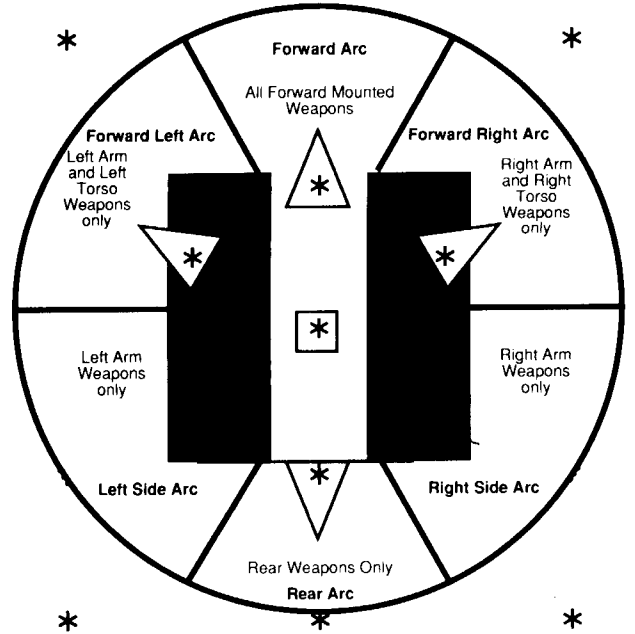
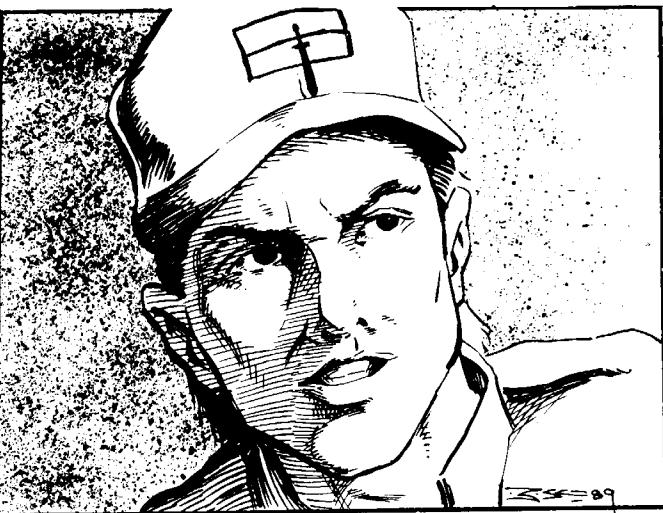

Legal Placement

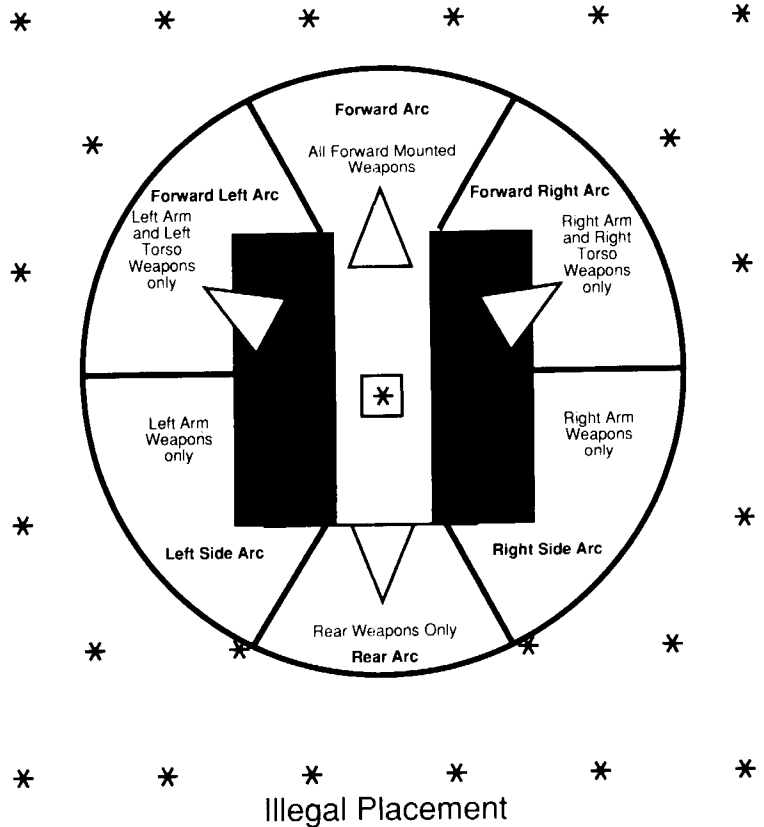

Illegal Placement

In the sequence of play, treat a 'Mech as a soldier, moving during its team's Movement Phase. For all movement and combat purposes except where noted, consider the 'Mech to be at the center dot. Before the 'Mech moves, the controlling player must declare if it is walking, running, or jumping. This determines the number of Movement Points it has available.

BATTLETROOPS

Like a soldier, the 'Mech moves from dot to dot, paying the listed movement costs for crossing various terrain features. Count only terrain features crossed by the center cutout, not terrain features that are simply covered by the template. To move to a new dot, shift the template so that the center is over the new dot.

The triangles on the template show where the 'Mech may move next. The template may be rotated one dot to the left or right at no MP cost. The player is not required to rotate the template. This reflects the fact that the 'Mech can twist so that its torso is not pointing in the same direction as its legs.

The player can mix rotation and non-rotation during movement as he desires. He may not shift the template more than one dot left or right without moving forward at least 1.

'Mechs cannot walk through normal doors or windows; they can only crash through the walls of a building. Movement through buildings is covered in the **Buildings** section of the rules.

In addition, a 'Mech can also walk through tree trunks. It costs 5 MP to walk through a tree trunk. After a 'Mech has walked through a trunk, cover the tree with a Splinters counter, which is treated as undergrowth.

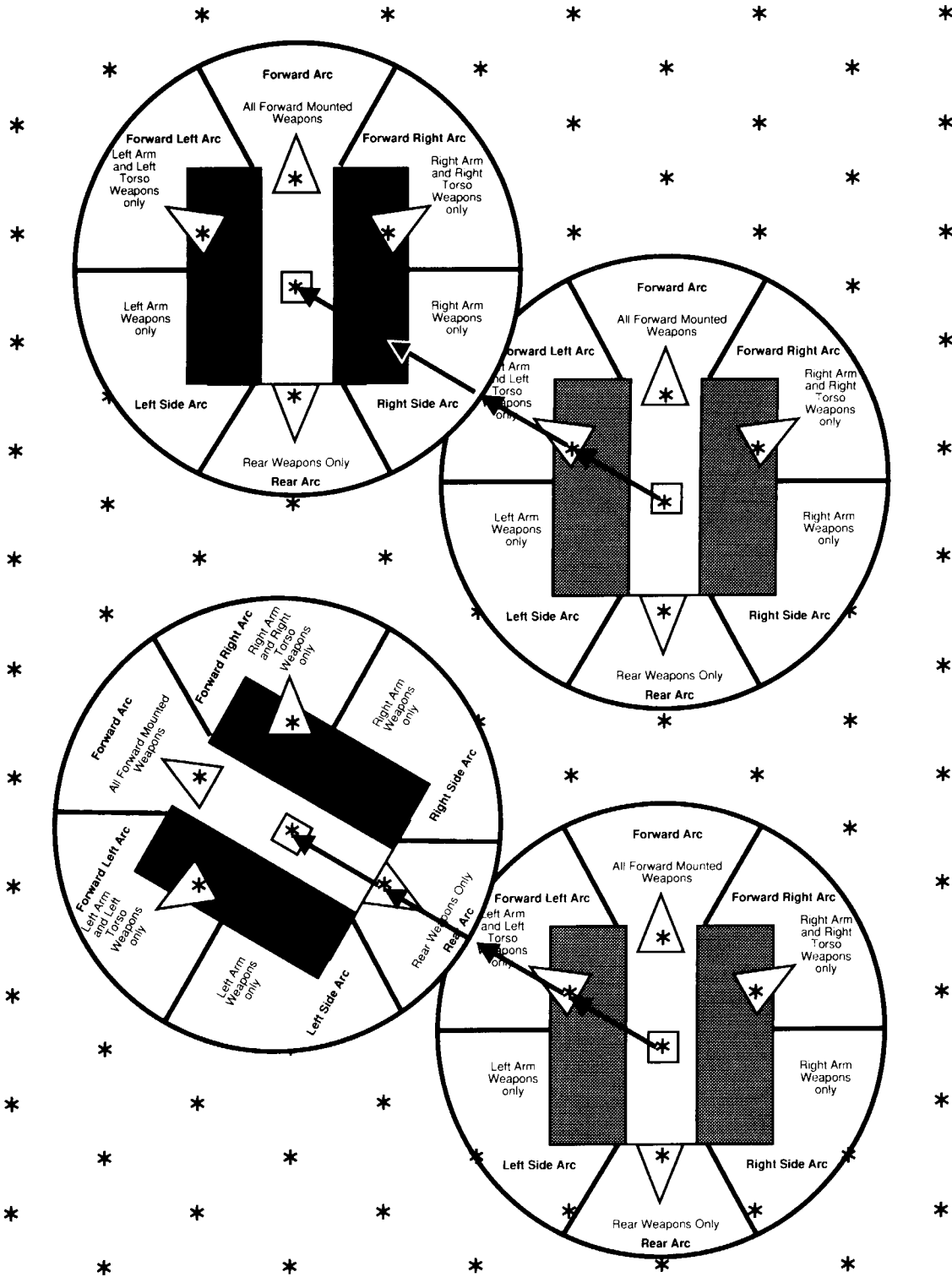

Piloting Skill Rolls

All normal **BattleTech** *Piloting* Skill Rolls, with their attendant modifiers, are used in **BattleTroops**. Resolve each roll immediately when the situation occurs.

Falling

If a 'Mech falls, use the scatter diagram to determine the direction it falls and replace the 'Mech Template with the Fallen 'Mech Template with the arrow point in the direction of the fall and the cut-out square placed over the 'Mech's location before it fell.

A falling 'Mech crushes any trees and undergrowth in its path. It might also crush a building. If a building's Construction Factor (see table in the Buildings section) is less than a falling 'Mech's tonnage, all sections of the building covered by the Fallen 'Mech Template are crushed.

If the building's Construction Factor is greater than the 'Mech's tonnage, the structure supports the 'Mech, which might not fall to the ground, depending on the building's height and distance from the 'Mech.

If the 'Mech starts its fall more than one dot away from the building or if the building is Level 1 or 2, the 'Mech does fall. Consider the 'Mech to be lying across the roof of the building, using that elevation to determine falling damage and targeting line-of-sight.

If the 'Mech starts its fall from a dot adjacent to a building that is Level 3 or 4, the building supports the 'Mech and keeps it from falling. The normal 'Mech Template is not removed, though the 'Mech still must stand up in the next turn before it can move, and it still sustains falling damage.



Any fall leaves the 'Mech face down, though the damage from falling is applied to the side of the 'Mech based on the direction it fell. For example, a 'Mech that falls through its Forward Right or Right Side arc sustains damage on its right side. A 'Mech that falls through its Forward arc takes damage on the front.

Determine the amount of damage from the fall according to the **BattleTech** rules, counting two **BattleTroops** levels or fraction thereof as one **BattleTech** level.

When the template lies across terrain of varying height, use the highest elevation as the stopping point when calculating the distance fallen, disregarding trees, undergrowth, and crushed buildings. The minimum distance fallen is always 1 level, even if the 'Mech fell uphill.

A 'Mech that falls cannot expend any more Movement Points for the remainder of the friendly phase. The 'Mech may not activate firing arcs, making it incapable of offensive action until the next friendly Movement Phase.

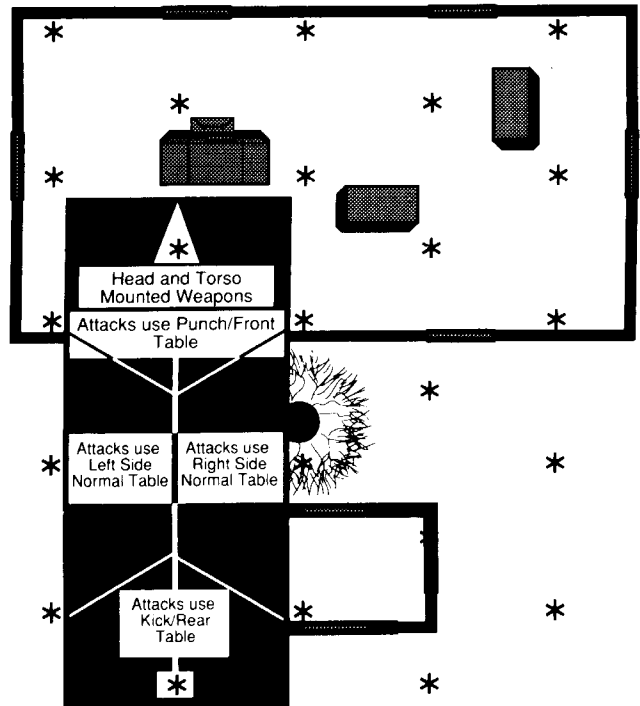

For example, a 20-ton *Wasp* falls through its right arc as shown. The small building is Light, with a CF of 15, and thus it is crushed. Place Rubble counters at the 'Mech's feet and on the dot in the crushed portion of the building. The tree is also crushed and should be covered with a Splinters counter. The larger building is a Level 3 Heavy Building with a CF of 90. The 'Mech falls against its roof, where it comes to rest. The distance fallen is negative (from Ground Level to a Level 3 building), and so falling damage is calculated at a fall of one level, applied to the right side.

If the small building had a Construction Factor of 20 and a height of 3, then the Fallen 'Mech Template would not have been used, though the 'Mech would still have taken falling damage and would still have to get up next turn.

BATTLETROOPS

Standing Up

After a 'Mech falls or drops to the ground, every attempt to stand up creates one heat point and costs 2 MP. Standing up requires a successful *Piloting Skill Roll*. The player may make as many rolls as he needs, as long as there are MP available.

If the attempt is successful, replace the Fallen 'Mech Template with the normal 'Mech Template, centered on the dot that the 'Mech originally fell from but with any facing.

Skidding

In the urban environment depicted on the **BattleTroops** map, all clear terrain is considered to be paved. This has no impact on infantry movement, but it does affect 'Mech and vehicle movement. The Skidding rules listed here are modifications from the ones given in **BattleTech** to account for differences in scale and time.

A 'Mech that makes a facing change (turns the template) while running has a chance to fall and skid. Whenever turning the template while running, the player should make a *Piloting Skill Roll*. If the roll fails, the 'Mech falls as normal and takes damage. If the Fallen 'Mech Template does not land on a building with a CF greater than the tonnage of the 'Mech, the 'Mech slides along the original direction of travel until some portion of the template hits a building with a CF greater than its tonnage. Trees and buildings that cannot stop the 'Mech are crushed. 'Mechs that skid off the map are considered to be out of the game.

The skidding 'Mech takes damage on its fallen side equal to half of its tonnage. When the 'Mech hits a building with a CF greater than its tonnage, it sustains normal charge damage, applied to the side that struck the building.

For example, the *Wasp* below is running and attempts to make a facing change. The player fails the roll, and the *Wasp* falls as indicated. It did not land on a substantial building, and so the 'Mech skids in the direction indicated. The small building has a CF of only 15, and so the 'Mech crushes it as well as the tree. The 'Mech skids into the larger building, with a CF of 40, and stops. The *Wasp* takes 20 points of damage on its Left Side for its original fall, 10 points for the skid, again on the Left Side, and it takes 2 points on its Right Side for hitting the building.

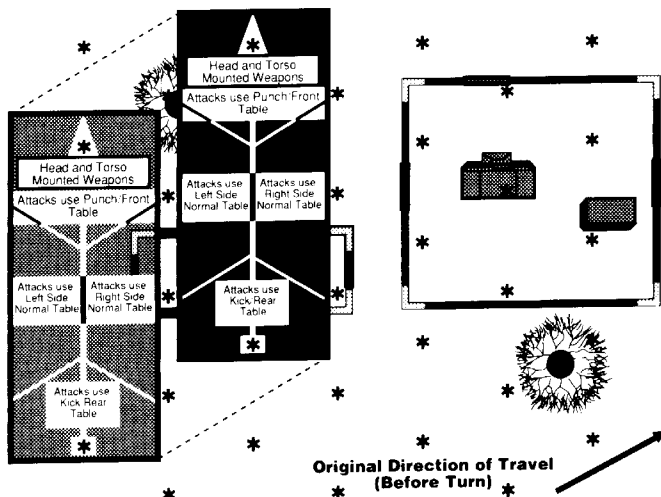

Note that skid rolls are made only for changing the alignment of the template, not simply moving to the dots to the left or right of the 'Mech.

Jumping

Rather than walking on the ground, jump-capable 'Mechs can jump to a new location in the same manner as described in **BattleTech**. A 'Mech can jump as high and far as its **BattleTroops** Jumping MP. The 'Mech builds up one heat point for every 5 dots, or fraction thereof, with a minimum of 3 heat points built up for any jump.

For line-of-sight purposes, a jumping 'Mech is considered to be 4 Levels higher than the terrain or building it is crossing. All other **BattleTech** Jump rules stay the same.

COMBAT

Many of a 'Mech's weapons were not designed for anti-personnel fire and thus do a poor job of it, especially at close range. The 'Mech fires its automatic and semi-automatic weapons at targets that enter its firing arcs as does any soldier in **BattleTroops**. It fires its area-effect weapons at the end of movement. Except where noted below, follow all **BattleTroops** rules for combat.

Line-of-Sight

A 'Mech must have a valid line-of-sight to its target before it fires a weapon. It may not fire at a target that is within the circle of the 'Mech Template. Determine LOS from the center dot to the target dot. When a soldier is firing at a 'Mech, however, he needs only a line to any point on the 'Mech Template.

'Mechs are 4 Levels tall in **BattleTroops**. Thus, only Level 4 terrain or higher blocks LOS. Level 2 or 3 terrain does block fire from a 'Mech's leg-mounted weapons. Level 2 or 3 terrain also provides the 'Mech with partial cover from return fire. See the Anti-'Mech Fire section of the rules for more details.

A 'Mech's legs block line-of-sight, but a LOS can pass through the gap between the legs if the attacker and the target are not more than 2 levels higher than the terrain where the 'Mech is standing.

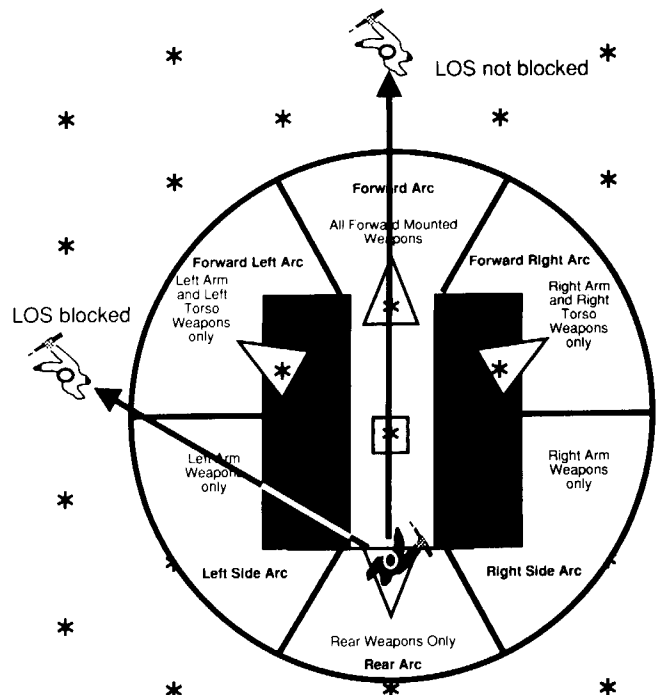

Firing Arcs

The 'Mech Template is divided to show six firing arcs; the Front Arc, the Right and Left Forward Arcs, the Right and Left Side Arcs, and the Rear Arc. All weapons except those mounted in the back of the 'Mech can fire into the Front Arc. Only weapons mounted in the designated sections of the 'Mech can fire into the other arcs. All of the weapons in a section must point into the same arc. Thus all of the weapons in the Left Arm fire into the same arc, while those in the Left Torso can be fired into a different or the same arc.

After the 'Mech moves, the player designates where the weapons are pointing by placing the appropriate counter in a firing arc. Remember that weapons mounted in the Head, Center Torso, and Legs may fire only into the Front Arc, while Rear-mounted weapons may fire only into the Rear Arc.

For example, a *Crusader* finishes its movement, and the player places the Right Arm counter in the Right Side Arc. He places the Right Torso counter in the Front Arc, and the Left Arm and Left Torso counters in the Left Forward Arc. The Crusader's Head weapon automatically covers the Front Arc, as do the two Leg-mounted SRMs.

To-Hit Number

The Base To-Hit Number for all 'Mech weapons is 6, to which the normal **BattleTroops** modifiers apply. Standard modifiers for movement, heat buildup, 'Mech damage and *Gunnery Skill* as described in **BattleTech** also apply. Do not use target modifiers.

'Mech weapons often fire at targets closer than their minimum range when they engage infantry. In this case, add 4 to the weapon's Modified To-Hit Number.

The player must roll the Modified To-Hit Number or greater on 2D6 to hit the target. Any other result is a miss.



Damage

'Mech weapons are rated as any other weapon for the damage that they inflict. Most 'Mech weapons cause enough Lethal Damage to guarantee the death of a foot soldier. Though high To-Hit Numbers are a mitigating factor, unsupported infantry do not last long in a head-to-head confrontation with a 'Mech.

Following is a list of weapon types and their anti-personnel effects in **BattleTroops**.

Machine Guns

A 'Mech's Machine Guns are its primary anti-personnel weapons. A Machine Gun is an automatic weapon and therefore engages every target that enters its firing arc.

Lasers and PPCs

These weapons were designed for penetrating armor, not for laying down suppressing fire. This makes these weapons ineffective against infantry.

Lasers and PPCs are fired as semi-automatic weapons, only once per turn. Lasers and PPCs can fire at only one target and do no collateral damage to anyone else.

Autocannon

An Autocannon spits out a stream of shells that explode on impact in a ring of deadly fragments. Treat Autocannons like **BattleTroops** area-effect weapons. They fire at the end of movement, requiring an expenditure of 5 MP.

The 'Mech pilot chooses a target impact dot and calculates the Modified To-Hit Number. If the round misses, follow the scatter procedure for area-effect weapons. Calculate damage from an AC round in the same way as from a hand grenade or area-effect weapon but using damage amounts listed on the 'Mech Weapons Table.

Long-Range Missiles

An LRM cannot be used effectively at the distances depicted on the **BattleTroops** board, almost always firing at less than their minimum range. When an LRM misses its target, follow the scatter procedure for hand grenades. Thus a second die roll shows the distance from the target dot after direction has been determined.

Short-Range Missiles

An SRM can be used against infantry with some effectiveness. Treat the SRM exactly like autocannon for targeting and damage.

'Mech Flamers

'Mech Flamers are energy weapons that tap into the super-heated plasma of the 'Mech's fusion reactor. Though it causes relatively little damage, a Flamer can start fires. See the **Flamers** and **Infernos** section and the **Fire** section of the rules for an explanation.

Physical Attacks

Against Infantry

The only way for a 'Mech to make a Physical Attack on an individual soldier is to walk on him. If the center of the 'Mech Template enters a dot occupied by a soldier, the soldier must roll 5 or higher on 2D6 to avoid being stepped on and killed.

If the soldier's Movement Point Allowance is less than 8, modify this Avoidance Number by +1 for every MP he has less than 8. Add +3 to the Avoidance Number if the soldier is inside a building that the 'Mech is walking through.

Against Buildings

'Mechs can walk through buildings as well as Punch or Kick a breach in a wall. See the **Buildings** section of the rules for details.

HEAT

'Mechs build up and dissipate heat per the normal **BattleTech** rules. A player should keep track of heat during both friendly and enemy movement, dissipating heat per normal **BattleTech** rules. Make Avoid rolls for Shutdown and Ammunition Explosion before the start of the next turn, applying the effects immediately. Movement and fire modifiers caused by heat are in effect throughout the next turn.

CONSCIOUSNESS ROLLS

Players make normal Consciousness Rolls for MechWarriors throughout the turn as the result of cockpit hits, heat buildup, falls, and so on. If a roll fails, the MechWarrior loses consciousness, and the 'Mech cannot function until the pilot regains his senses. Consciousness Recovery Rolls are made only during the End Phase of the turn.

ANTI-'MECH FIRE

Unless noted otherwise, treat a 'Mech as a normal soldier for combat resolution. For line-of-sight purposes, a standing 'Mech is considered to be 4 Levels tall. A fallen 'Mech is 1 Level tall. Infantry weapons may fire at a 'Mech only at short range for the weapon. Long-range fire is always ineffective.

Personal Weapons

Personal weapons have little effect on a 'Mech, though it is possible to cause slight damage. In the scope of **BattleTroops**, a 'Mech is a huge object. Though a foot soldier finds a 'Mech an easy target, the chance that the hit will damage the 'Mech is small. The roll when shooting at a 'Mech is to see if damage was done, not to see if it was hit.

Except for pistols and hand grenades, all other personal weapons can damage a 'Mech. The To-Damage Number against a 'Mech is always 11. There are no modifiers, even for wound status or partial cover. If the roll succeeds, the weapon does 1 point of damage to the 'Mech, applied per **BattleTech** rules. If there is no intervening Level 3 terrain, the firing player can use the Punch Table or the Kick Table to determine hit location on the 'Mech. If there is Level 3 terrain intervening, the player must use the Punch Table to resolve the attack.

Area-Effect Weapons

Area-effect weapons normally fire armor-piercing rounds that can penetrate a 'Mech. The Base To-Hit Number for an area-effect weapon to hit a 'Mech is 4. This is modified by partial cover and the wound status of the firing soldier.

If the weapon hits, the location is resolved in the same manner as described in the Personal Weapons section. The damage is listed in the Armor-Piercing Value column of the Area-Effect Weapons Table.

Before rolling the dice, the player may attempt to place his attack by accepting a +2 modifier to the To-Hit Number. If the attack hits, he may then use the Punch or Kick Table to resolve damage. If Level 3 blocking terrain intervenes, the To-Hit Number is automatically modified by +2 and successful attacks are resolved on the Punch Table.

Use the normal scatter procedure for area-effect weapons if an attack misses.

Support Weapons

Support weapons attack a 'Mech in the same manner as an area-effect weapon, causing their listed APV damage against the 'Mech. Note that an automatic weapon engages a 'Mech in every dot of its firing arc that the 'Mech enters. A smart 'Mech pilot will stop moving once a support weapon fires and wipe it out before he advances.

Satchel Charges

A soldier can carry a special anti-'Mech satchel charge instead of a secondary weapon. To use the charge, the soldier must enter the center dot of the 'Mech Template and spend 3 MP to prepare the charge. The player then rolls 2D6. On a result of 9 or more, he has planted the charge in a potentially dangerous location on the left or right leg (attacking player's choice). The 'Mech player then immediately rolls on the Critical Hit Effects Table, applying damage to the appropriate leg of the 'Mech. The soldier sustains no damage. An unsuccessful placement attempt does not expend the satchel charge.

It costs the soldier 2 MP to enter any dot of the 'Mech's legs. The soldier can walk between the legs for 1 MP per dot. The 'Mech cannot attempt to walk on the soldier until its own Movement Phase.

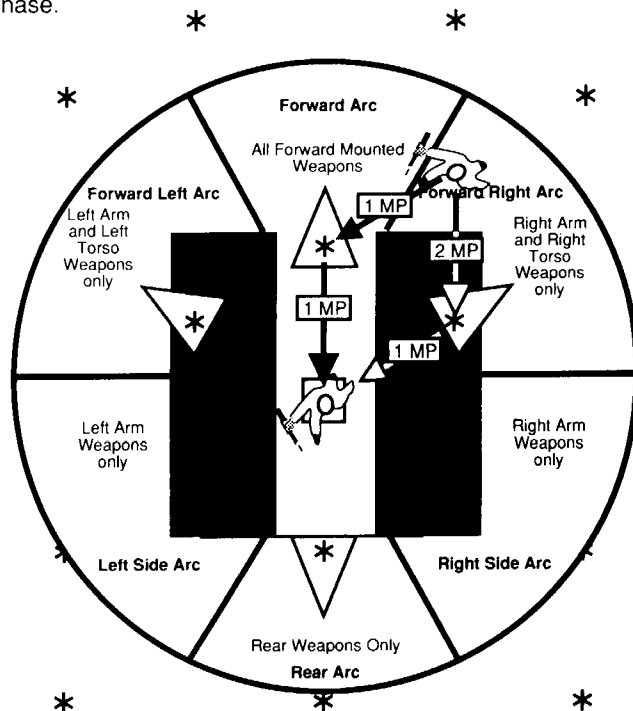

Satchel Charges may also be used against 'Mechs in the manner described previously for throwing or dropping.

Infantry Flamers and Infernos

Infernos and Flamers may be used against 'Mechs to raise their heat levels. These weapons have a Base To-Hit Number of 4 against 'Mechs, and this is modified by the wound status of the attacker and by partial cover.

A successful Flamer or Heavy Flamer attack increases the 'Mech's heat buildup for the turn, a Flamer by 1 point and a Heavy Flamer by 2 points.

A successful Inferno attack increases a 'Mech's heat by 10 points for the next three End Phases. Additional Inferno hits only prolong the heat buildup. Thus two Inferno hits in one turn affect a 'Mech for six End Phases.

Successful Flamer and Inferno attacks affect only the 'Mech, not terrain. If such an attack misses, follow the scatter procedure for area-effect weapons and set the appropriate areas on fire.

MINES

If a scenario includes anti-personnel or anti-vehicular mines, the player should secretly record their positions before the game. Anti-personnel mines can be set anywhere, including in the upper floors of a building. Anti-vehicular mines must be outside.

When any soldier, vehicle, or 'Mech moves to a dot containing an anti-personnel mine, it explodes. Resolve damage as if the mine were a satchel charge, and continue the Movement Phase.

An individual soldier does not set off an anti-vehicular mine, but if any portion of a vehicle or 'Mech Template covers the dot, the mine explodes and causes 6 points of damage to the appropriate leg of the 'Mech or side of the vehicle. A mine can explode only once.

Vibrabombs are special anti-vehicular mines preset to detonate under a preset weight. The mine explodes when covered by a vehicle or 'Mech within 10 tons of the preset tolerance. Vibrabombs do 10 points of damage rather than 6.

FIRE

Flamers and Infernos cause direct damage to infantry, but their secondary effects create more havoc. By starting fires, these weapons can cause enemy troops to abandon positions that were impervious to other weapons.

Fire provides partial cover one level high. Soldiers can see through it, but any attack into or through it has a +1 modifier to the To-Hit Number.

A foot soldier who starts the turn in an area that is on fire or who moves through such an area immediately sustains 1 point of Lethal Damage. The soldier takes an additional point for every dot entered. A soldier who ends his movement on a dot that is on fire sustains 8 points of Lethal Damage. If wounds cause a soldier to drop prone in an area that is on fire, he takes 8 points of Lethal Damage in addition to the 1 point for entering the dot.

If the center dot of a 'Mech Template passes through an area that is on fire, add 1 point of heat for each dot entered. If the 'Mech stops on a dot that is on fire, it gains 2 heat points.

Vehicles can pass through fire areas without damage, but anyone on the outside of the vehicle sustains 1 point of Lethal Damage for every dot entered by the vehicle. If a vehicle ends movement on a burning dot, roll 2D6. On a result of 8 or more, the vehicle's engine compartment catches fire, causing the entire vehicle to burn. Place a Flames counter on each dot on the template. Both the interior and exterior of the vehicle are considered to be on fire.

Most **BattleTroops** games end in less than a minute of game time (12 turns), and so fire does not spread as it does in **BattleTech**, nor does it go out. Once placed, the fire continues to burn in the indicated area. Buildings, trees, and undergrowth are unaffected. Remember that all partial cover modifiers are cumulative, so attacks that pass through burning undergrowth or branches modify the attack by +2 (+1 for the undergrowth and +1 for the fire).

BUILDINGS

Buildings are rated to indicate the strength of construction, Light, Medium, Heavy, or Hardened. Each of these types has a Construction Factor (CF), per the table below.

BUILDING TABLE			
Building	CF	MP	Piloting Skill Modifier
Light	15	6	0
Medium	40	18	+1
Heavy	90	24	+2
Hardened	140	30	+5

Unless designated otherwise, all buildings are assumed to be Medium.

A 'Mech can crash through the walls and the interior of a building by expending the MP cost listed in the table. For each interior dot entered, the player should make a *Piloting Skill Roll* to avoid damaging his 'Mech, as per the normal **BattleTech** rules.

As the 'Mech walks through the building, it knocks holes in walls 4 Levels high and about 5 meters (2 dots) across. To indicate this, place a Rubble counter on each interior dot of the building that the 'Mech moves through. Treat the Rubble counter as a window for line-of-sight, partial cover, and movement.

Foot soldiers rarely carry weapons with sufficient firepower to breach a building wall. The weapons carried on 'Mechs and vehicles, however, can make large holes in the walls of all but the heaviest building.

To create a breach in a wall, the weapon's maximum Lethal Damage must exceed the Construction Factor of the building. Target any dot inside the building. The shot always hits the desired location, so no To-Hit Roll is needed. Place the Breach counter where the line-of-sight crosses the wall. Treat the breach as Rubble. If the breach is not on the ground floor, place an appropriate Floor counter next to it.

Any Lethal Damage in excess of the CF of the building passes on to any soldier standing on the interior dot that served as the targeting location of the shot.

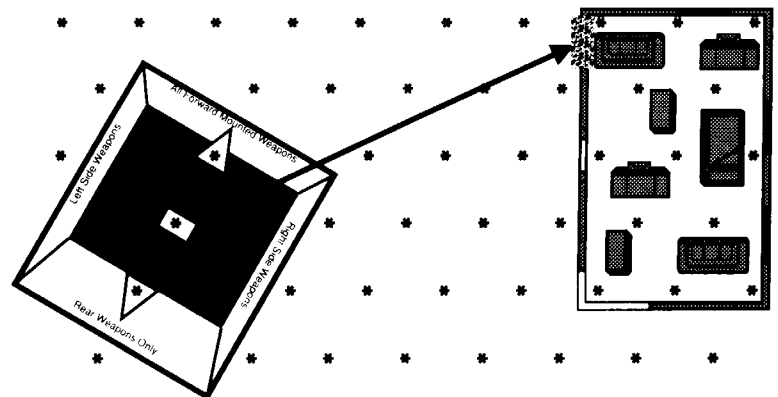

A 'Mech may attempt to punch or kick a hole in the building. This expends the same number of MP as moving through the building but requires no *Piloting Skill Roll*.

Punches can be directed at building Levels 1 through 4 higher than the terrain where the 'Mech is standing. Kicks can be made only against the building level the same as the terrain where the 'Mech is standing.

VEHICLES

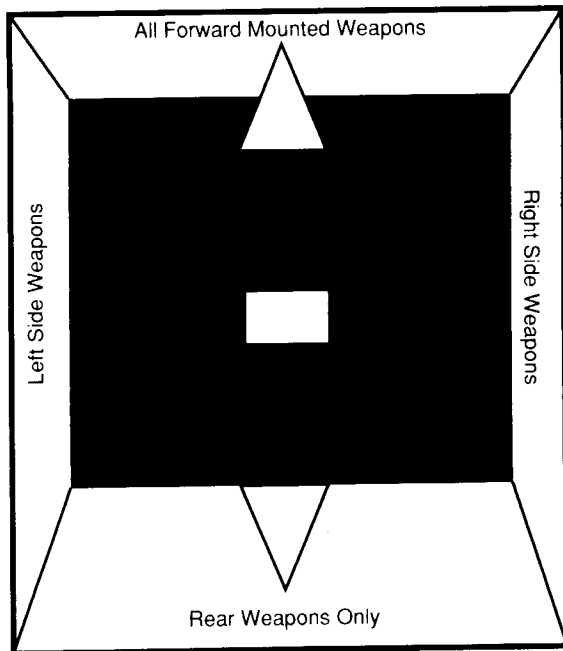

In addition to using BattleMechs, players may wish to use conventional ground combat vehicles in **BattleTroops**. Ground vehicles use all of the rules for 'Mechs except where noted below. Multiply a vehicle's listed speed by 5 to obtain its **BattleTroops** MP.

If using the Open Hatch and Crew Abandonment rules, players must fill out record sheets for vehicle crewmembers. All crewmembers have a pistol and a knife, and one member of the crew also has an SMG.

The number of crewmembers is based on the vehicle's tonnage, per the chart below.

VEHICLE TABLE	
Tonnage	Crew Members
0 - 10	1 (Driver only)
11 - 30	3 (Commander, Gunner, Driver)
30+	4 (Commander, Gunner, Driver, Loader)

MOVEMENT

A vehicle can move to the dot directly forward or backward, changing its facing by one dot to the left or right after each dot moved. All other movement rules and restrictions apply.

Soldiers expend 2 MP to enter a dot on the Vehicle Template.

Skidding

Like a 'Mech, a vehicle that is moving at flank speed can skid when it attempts to realign the template. Unlike a 'Mech, the vehicle does not fall. Simply move the Vehicle Template along the original direction of travel until it hits a building with a CF equal to or greater than its tonnage. The skidding vehicle takes normal ramming damage on the side that strikes the building.

COMBAT

Because of their weapons, vehicles have many similarities to 'Mechs in **BattleTroops**, but there are important differences, as described below. Unless stated otherwise, the rules for 'Mechs also apply to vehicles.

Line-of-Sight

Vehicles are 1 level tall instead of the 4 levels of 'Mechs. For line-of-sight purposes, treat the vehicle as a foot soldier who is standing up.

A vehicle determines its LOS from the center dot of the template. For sighting purposes, a foot soldier uses line-of-sight to any dot on the template, though range is always counted to the center dot.

For example, the vehicle below is next to a Level 1 building. The crew of the vehicle cannot see the soldier because the vehicle's LOS passes through the building. The soldier, on the other hand, has a valid LOS to the vehicle.

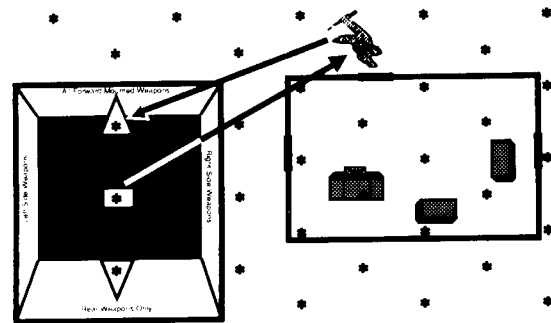

The black area of the vehicle blocks LOS in the same manner as a Level 1 terrain feature.

Firing Arcs

The firing arcs for the weapons mounted in the hull of the vehicle are defined on the template. When the vehicle completes its movement, the controlling player may place a 4 MP Firing Arc counter from the center dot, pointing any direction. This arc costs nothing to place and represents the direction that the turret-mounted weapons are facing.

Like 'Mechs, vehicles cannot fire at soldiers who have moved onto any of the dots on the template.

RIDING VEHICLES

Certain vehicles, known as Armored Personnel Carriers (APCs), can carry infantry inside. Every APC has a ramp that lowers from the back to load and unload infantry.

An APC cannot move during the turn that it dismounts or mounts infantry, but it can expend MP to fire weapons. A soldier who moves to the center dot of an APC with its ramp down and expends two MP is considered inside and should be removed from the map. An APC can carry seven soldiers and their equipment. This is the only time that more than one soldier can occupy the same dot.

The ramp is considered to be down during the turn that the APC is mounting or dismounting infantry. It is also down during the enemy player's preceding turn, allowing the opposing player an opportunity to fire into the vehicle from the rear. While the ramp is down, any fire that enters the rear arc of the vehicle goes inside. Make a normal To-Hit roll, with no additional modifier for entering the door. Damage from any type of weapon affects everyone in the vehicle, including the crew.

Once inside the vehicle, soldiers travel with it as it moves. Rather than riding inside, soldiers can ride on the outside of the vehicle. It still costs 2 MP to enter or leave a dot on the Vehicle Template. The vehicle cannot move during the turn that the soldiers are climbing on or off, though it may expend MP to fire weapons. Only one soldier per dot may ride on the outside of the vehicle.

A soldier riding on the outside of a vehicle can set firing arcs as normal. A riding soldier is considered to be in clear terrain and cannot gain To-Hit modifiers by assuming a prone position on the vehicle. If a soldier must drop prone due to wounds, he falls off the vehicle instead, sustaining an additional point of Lethal Damage.

Any soldier can move onto a vehicle dot at any time in the game, but only soldiers who have mounted the vehicle using the above rules will travel with the vehicle when it moves. Other soldiers remain where they are as the vehicle moves away.

OPEN HATCH

The rules presume that the crew operates inside the vehicle, with all of its hatches closed. If the controlling player wishes, he can have the vehicle commander open his hatch and ride with his head outside the vehicle. The vehicle commander can then operate a pintle-mounted Light Machine Gun mounted on the outside of the vehicle. The commander is considered to be in the center dot of the Vehicle Template. After the vehicle has moved, the commander can spend up to 6 MP to set a Firing Arc for his Light Machine Gun.

The Light Machine Gun can be used by any soldier who is riding on the outside of the vehicle as long as he prepares the weapon and is on the center dot of the vehicle.

When the hatch is open, the vehicle commander can be engaged normally. Treat all attacks against the exposed commander as if he were surrounded by a window. Thus the commander has an automatic +1 partial cover modifier and is not affected by any explosions except those centered on his dot.

If the hatch is open and a hand grenade or other area-effect weapon lands on the center dot of the vehicle, the round goes off inside, destroying the vehicle and killing all of its occupants.

If the commander is knocked unconscious or killed, a vehicle's total MP Allowance is halved.

CREW ABANDONMENT

Unless the vehicle explodes or sustains a Crew Killed result, destruction of the vehicle does not mean the death of the crew or passengers. When the vehicle is destroyed by any other means, all crewmembers and infantry on board receive 1D6 worth of Lethal Damage. Anyone who is still conscious can leave the vehicle. Crewmembers leave through the center dot. If the vehicle is an APC, the infantry and crew can leave by either the center dot or the rear arc. One of the vehicle crewmembers is armed with an SMG, while the others have pistols. It costs 2 MP to leave a vehicle. Once out, the crew members are treated as a separate squad for leadership and morale purposes and are subject to all infantry rules.

HIDDEN UNITS

Certain scenarios call for soldiers to start in hidden positions. Rather than placing the pieces on the map, the player should record the location of each soldier. Soldiers may be hidden only inside buildings. The soldier is assumed to have a 6 MP Firing Arc. The alignment of this Firing Arc should be recorded by using the direction on the scatter diagram. This Firing Arc cannot be changed as long as the soldier remains hidden.

Soldiers stay hidden until they move, fire a weapon, or engage in any other type of action. Once a hidden soldier has performed one of these actions, place his counter on the map and treat him according to all normal movement and combat rules. A soldier is spotted if an enemy soldier, not a 'Mech or vehicle, comes within 3 dots of the hidden trooper and has a valid line-of-sight to him. If the soldier is spotted, place his counter and his Firing Arc counter on the map.

VEHICLE VS. VEHICLE OR 'MECH COMBAT

It is assumed that only one side has 'Mechs or other vehicles. If both sides do have vehicles, however, resolve combat with the following guidelines. These guidelines are not a complete set of rules. We strongly recommend that players use **BattleTech** to resolve 'Mech on 'Mech or vehicle combat.

MOVEMENT

Movement is as normal, but the templates may not overlap at the end of any player's turn.

FIRE COMBAT

'Mechs and vehicles firing at one another use firing arcs and LOS as in **BattleTroops**. The remaining portion of the combat is resolved according to **BattleTech** rules. Range is considered to be Short. Use all **BattleTech** fire modifiers. Calculate target movement modifiers by dividing the number of dots that the 'Mech or vehicle moved in its last turn by 12 and rounding to the nearest whole number. Hit location and damage allocation are resolved with **BattleTech** rules.

PHYSICAL COMBAT

It costs 5 MP to make a Physical Attack. The two vehicles or 'Mechs involved must have their templates adjacent to one another. Death From Above requires the jumping 'Mech to have its center cut-out area over the center of the target's template.

Apply damage as normal for Punches, Kicks, and Death From Above. Calculate charge damage as normal for tonnage, but the distance multiplier is divided by 12, rounding fractions to the nearest whole number. For example, if a 20-ton *Wasp* charged a *Stinger* after moving 28 dots, the *Stinger* would receive $(20/10) \times (28/12)$ or 4 points of damage. The charging *Wasp* would receive 2 points.

A successful charge causes the attacking 'Mech to displace the defending unit 3 dots away from its current location, in the direction of the charge. An unsuccessful charge causes no movement by either unit.

After the displacement, the 'Mechs roll as normal for falling. 'Mechs cannot fall on one another; reroll for a new direction.

Other displacements due to Death From Above or Pushing move the 'Mech three dots in a direction indicated by the scatter diagram.

PLATOON ORGANIZATION

Infantry platoons throughout the Inner Sphere share a common structure that can be traced back to the Star League. Though mercenary and Periphery infantry platoons might vary, all House infantry units consist of a 28-man platoon divided up into four 7-man squads. The first three squads are considered the maneuver elements of the platoon. The fourth squad is armed with heavy weapons and normally provides fire support to the maneuver elements. The exception to this rule are jump-capable troops. Because of the difficulty of setting up and breaking down the larger support weapons, Jump Platoons do not have a fourth squad and therefore have only 21 soldiers.

Infantry platoons are traditionally commanded by a junior commissioned officer, who is assisted by a senior noncommissioned officer. These two individuals command the support squad in combat operations. Each maneuver squad is led by a noncommissioned officer, who is in turn seconded by two or more junior NCOs.

Infantry platoons are designated by two means: their primary weapon type and mode of transportation—foot, motorized, mechanized, or jump. Thus an SRM platoon would have a predominance of SRM weapons, and a Flamer platoon would have most of its soldiers equipped with Flamers and Infernos. Not every soldier in an SRM platoon is equipped with an SRM. A balance of weapon types that complement each other is essential for the success of an infantry unit.

Foot platoons have no transport assigned to them. Easy to raise and maintain, foot infantry are normally used for static defense in urban areas, where their lack of mobility is not a major detriment.

Motorized platoons do possess their own transport, small trucks, motor bikes, and the like. These vehicles normally have no weapons and are unarmored. Because of this, the vehicles are used only to get the infantry to the battlefield, where the soldiers dismount from a safe location and fight on foot as normal.

Mechanized platoons are similar to motorized platoons, except that the vehicles used are armored, possess weapons, and have an integral place in the combat tactics of the platoon. The vehicle is expected to carry its men (normally a squad) into the heat of battle, dismount them, and provide fire support. In addition to the normal 28 infantry men, the mechanized platoon also has enough personnel to man its vehicles.

Soldiers assigned to jump platoons have individual rocket packs, which give them the ability to fly limited distances. While in clear terrain, jump troops are about as mobile as their motorized cousins. In urban and built-up areas, they have a distinct advantage. Jump equipment is heavy and cumbersome. Because of this, jump platoons rarely have support weapons.

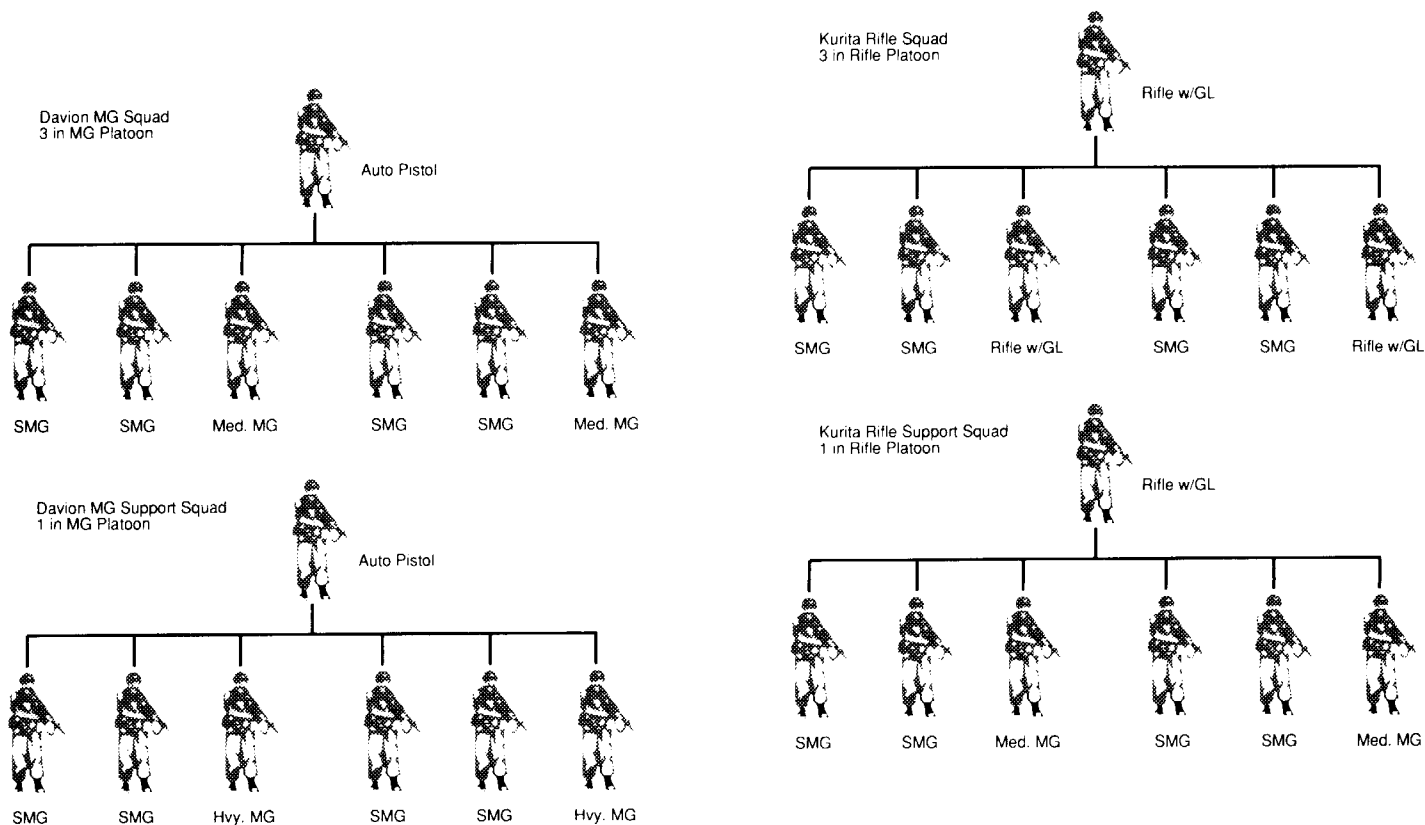

There are five basic platoon types: Rifle, Machine Gun, Laser, Flamer, and SRM. The type and number of weapons issued by the various Houses differ, but all five platoon types have similarities. Most soldiers in a Rifle Platoon carry SMGs, slug-throwing rifles, and light support and area-effect weapons. Machine Gun Platoons have a predominance of medium and heavy machine guns. Laser Platoons rely on Laser Rifles, Blazers, and small support lasers. Flamer Platoons are primarily used against 'Mechs, and they carry Infernos and hand-held Flamers. SRM Platoons use shoulder-fired versions of 'Mech SRMs and other area-effect weapons. In addition to a primary weapon, each soldier has a second weapon with a limited amount of ammunition. A soldier with an SRM, for example, also carries a pistol.

Cost, availability, and maintenance problems leave most infantry in the Inner Sphere with unsophisticated equipment and weapons: slug throwers, simple missile launchers, and the like. Even Laser Platoons have some of their men equipped with SMGs and Grenade Launchers. Similarly, foot soldiers have only a helmet and maybe a flak vest for personal equipment. Advanced weapons and equipment are found only with elite formations, such as Kuritan DEST Commandos or Davion MI6 Special Forces. Sometimes known as Heavy Infantry, these troops have access to such equipment as Gryojet Rifles, Man-Pack PPCs, and Combat Armor. Because these troops get only high priority tasks, their weapons mix and their tactical organization vary from one mission to the next.

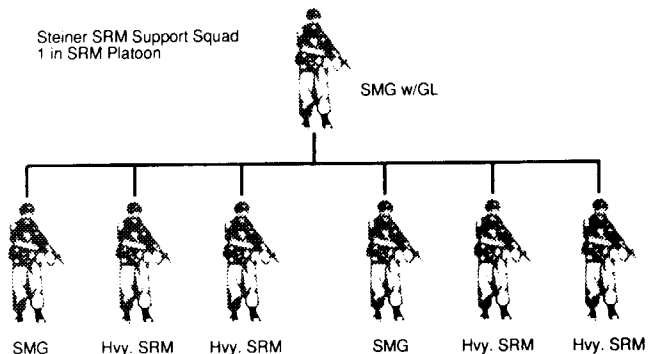
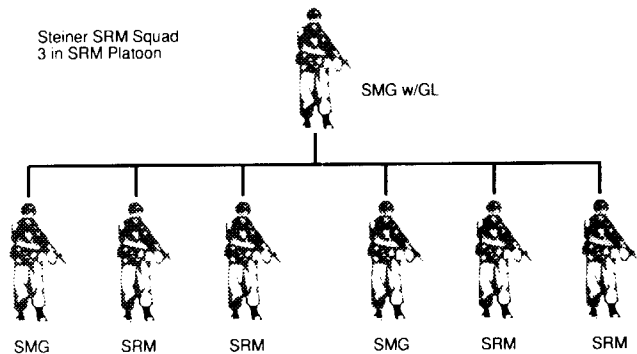
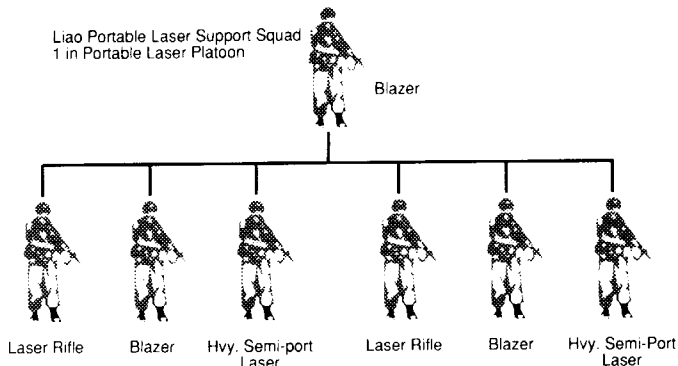
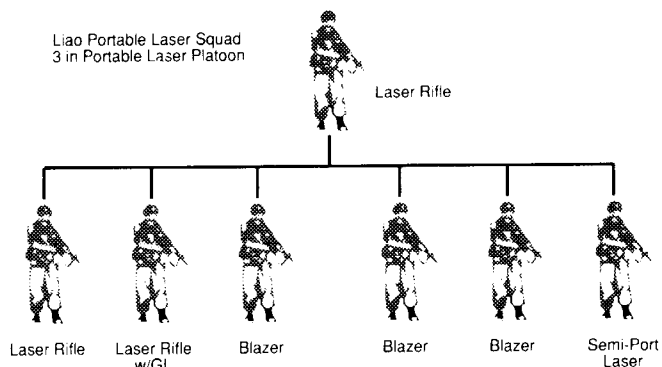
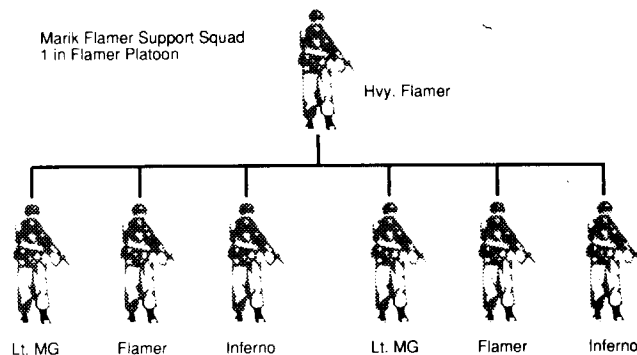
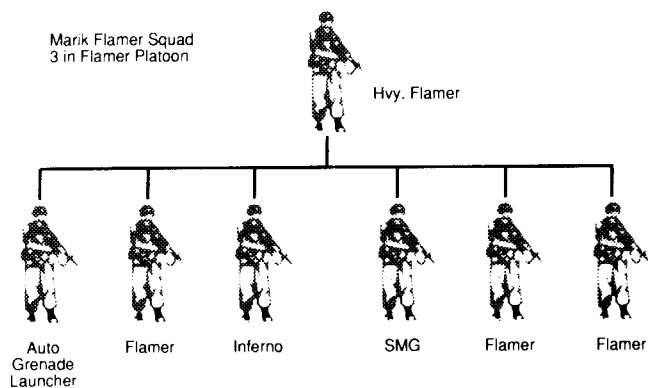

SCENARIOS

SIDE SHOW

Situation: Aldebaran (Chouchu, Northeast Sector) 1 September 3028

In the first wave of Davion assaults against the Capellan Confederation, elements of the 17th Kestral Mechanized Infantry were dropped on the planet of Aldebaran to support the 4th Davion Guards. The 17th's first objective was to assault the city of Chouchu. Quickly overrunning some companies of Liao infantry guarding the eastern approaches to the city, the 2nd Battalion entered the northeast outskirts of the city. Not wishing to charge pell-mell into an ambush, the commander of the 2nd Battalion temporarily halted his advance and sent a squad of dismounted infantry to reconnoiter to his south and west.

A third Liao infantry company was guarding the southeast portion of the city. Having lost contact with the company's sister units when they were overwhelmed by the Davion battalion, the commander decided to send a small element north to try to re-establish contact with them.

What occurred has happened countless times in the annals of warfare. Two small units, without any direction or plan, blundered into each other. Missions and objectives were forgotten as a violent and devastating firefight erupted.

Game Set-Up

This scenario uses the Basic **BattleTroops** rules. Lay out Maps 2 and 3 as shown.

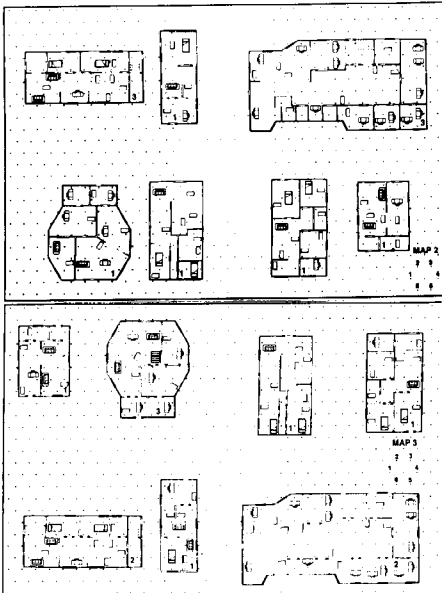

Defender

The Defender is the first squad of the 3rd Platoon, Bravo Company, Second Battalion, 17th Kestral Mechanized Infantry.
1st Squad 3rd Platoon B Company 2/17th (7 Men)
 Equipment (assigned at the player's discretion)

- 4 SMGs
- 2 Rifles
- 1 Blazer

Deployment

The squad enters the north end of the map on Turn 1 of the Davion player's turn.

Attacker

The Attacker is the 2nd Squad of the 1st Platoon, 3rd Company, 2nd Battalion, Aldebaran Home Guard Regiment.

2nd Squad 3rd Co. 2/Aldebaran Home Guard (7 Men)

Equipment (assigned at the player's discretion)

- 2 Rifles
- 4 SMGs
- 1 Blazer

Deployment

The squad enters the south end of the map on Turn 1.

Victory Conditions

The mission of both sides is to get information on the other, not to run up a body count. Therefore, victory is determined by the number of men that get to the opposite side of the map and then withdraw to friendly lines. Victory is determined using the following table:

VICTORY TABLE	
Davion Decisive Victory	Three or more Davion soldiers reach the northernmost row of dots and then withdraw off the southern map edge.
Davion Substantial Victory	Two Davion soldiers reach the northernmost row of dots and then withdraw off the southern map edge.
Davion Marginal Victory	One Davion soldier reaches the northernmost row of dots and then withdraws off the southern map edge.
Liao Marginal Victory	One Liao soldier reaches the southernmost row of dots and then withdraws off the northern map edge.
Liao Substantial Victory	Two Liao soldiers reach the southernmost row of dots and then withdraw off the northern map edge.
Liao Decisive Victory	Three or more Liao soldiers reach the southernmost row of dots and then withdraw off the northern map edge.

Note that it is possible for both sides to claim some level of victory. The game lasts for a maximum of 15 turns.

DRAGON HUNTING

Situation: Harrow's Sun (Fort Belvoir) 25 June 3029

During the Fourth Succession War, Wolf's Dragoons and the Draconis Combine engaged in what can only be described as a vendetta. Ignoring the pleas of both his Capellan allies and even his commanders on the Steiner front, Takashi Kurita committed what some might call an obscene amount of men and materiel against the Dragoons. Hammered into the ground, the Dragoons on Harrow's Sun, Glenmora, and Wapakoneta held on by the slimmest of margins.

On Harrow's Sun, the 4th Galedon Regulars laid siege to Gamma and Epsilon Regiments of Wolf's Dragoons in the city of Fort Belvoir. After futile frontal attacks, the Combine force dug tunnels underneath the Dragoon defenses and into the heart of the city. On 25 June, in concert with a general attack, Kurita soldiers poured forth from the tunnels and quickly seized important points inside of the city. In the wild melee that followed, the Dragoons were able to beat back the Combine attack, but many Kurita soldiers still lurked in the confines of the city.

The Dragoons began mopping-up operations inside the city the next day. This job was carried out with some trepidation, for many remembered that the Dragon's hunters could quickly become the Dragon's prey.

Game Set-Up

This scenario uses all Basic and Optional **BattleTroops** rules, including those for 'Mechs, Morale, and Leadership. Lay out Maps 1, 2, and 3 as shown.

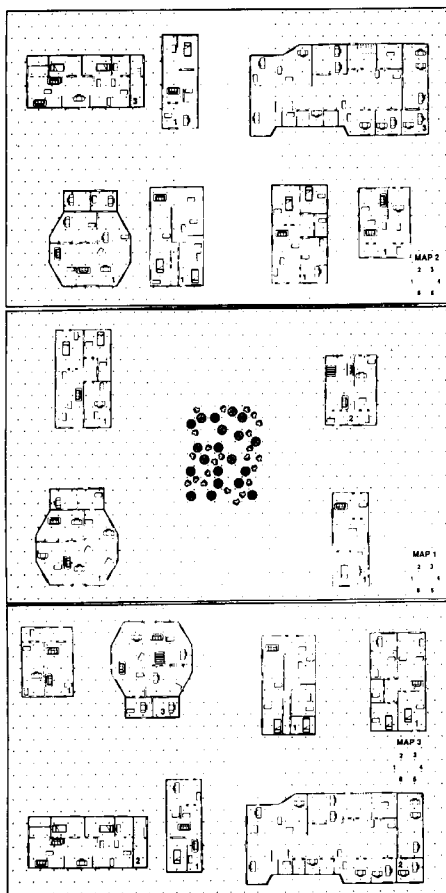

Defender

The Defender is the First and Second squads of the Security Company, 8th Galedon Regulars

1st Squad (7 Men)

1st Squad Leader: *Chu-i David Wylie*

Leadership Skill Rating: 3

Experience Level: Veteran

Equipment (assigned at the player's discretion)

2 SMGs

1 Heavy Semi-Portable Laser

2 Lt. MGs

2 SRMs

All men are equipped with Flak Vests.

The player may assign each man a Secondary Weapon of his choice.

2nd Squad (7 Men)

2nd Squad Leader: *Sergeant Handal Mashi*

Leadership Skill Rating: 2

Experience Level: Veteran

Equipment (assigned at the player's discretion)

4 SMGs w/Grenade Launchers

2 SRMs

1 Lt. MG

All men are equipped with Flak Vests.

The player may assign each man a Secondary Weapon of his choice.

Deployment

Both squads can set up hidden in any building on the map. Indicate each soldier's location, floor number, and the direction of his firing arc on the copy of the map included with these rules.

Attacker

The Attacker consists of one *Phoenix Hawk* from the 2nd Provisional Company of Epsilon Regiment of Wolf's Dragoons.

MechWarrior *Henry Bolan*, *Phoenix Hawk*, Piloting 3, Gunnery 3

Because of damage from the previous day's fight, the *Phoenix Hawk* has no operable jump jets. Additionally, the Dragoon player should remove 10 points of armor from the 'Mech.

Deployment

The Dragoon 'Mech must enter on the first turn during his movement phase anywhere along the north side of the map.

Victory Conditions

The Dragoon player wins if he breaks both Kurita squads, or kills or renders unconscious all of the Kurita soldiers. The Kurita player wins if he destroys the *Phoenix Hawk* or if the *Phoenix Hawk* leaves the map before the Dragoon player has won. The game lasts until one side can claim victory.

RACE AGAINST TIME

Situation: Cerant, An Ting (ComStar Compound) 3 January 3028

After months of enduring a heavy-handed effort by local Kurita commanders to discredit them, Wolf's Dragoons decided that the Kuritans had, in effect, voided the Dragoons' contract with the Draconis Combine and that the unit would seek employment elsewhere.

Some of the Dragoon regiments were stationed on planets far removed from their main base of operations on An Ting. In order to successfully withdraw from Kurita space, all Dragoon elements had to start out at the same time. The only way to arrange this was for Colonel Jaime Wolf to use ComStar to send a message ordering the move.

Unfortunately, civilian riots directed against the Dragoons, along with a Combine disinformation campaign, caused the ComStar facility on An Ting to shut its doors to all Wolf's Dragoon traffic.

On the night of 3 January 3028, Jaime Wolf sent a team of Seventh Kommandos to seize the ComStar facility and send the recall message to his far-flung pack. Under the command of Lieutenant Anton Shadd, the Kommandos seized the facility and Tech Chief Scott began to puzzle out a way to activate the HyperPulse generator. Kurita forces had been alerted, however, and began an assault on the building in an attempt to recapture it.

Lieutenant Shadd and his men needed to buy time for Chief Tech Scott, and it could only be purchased with their lives. If they failed, Wolf's Dragoons would be destroyed.

Game Set-Up

This scenario uses all of the Basic and Optional BattleTroops rules, including those for 'Mechs, Morale, and Leadership.

Lay out Map 4 as shown. For this scenario, the building represents the main ComStar transmission facility on An Ting. The building has a CF of 140 and is a Level 2 structure.

The second floor of the building contains the HyperPulse Generator control chamber at the indicated location.

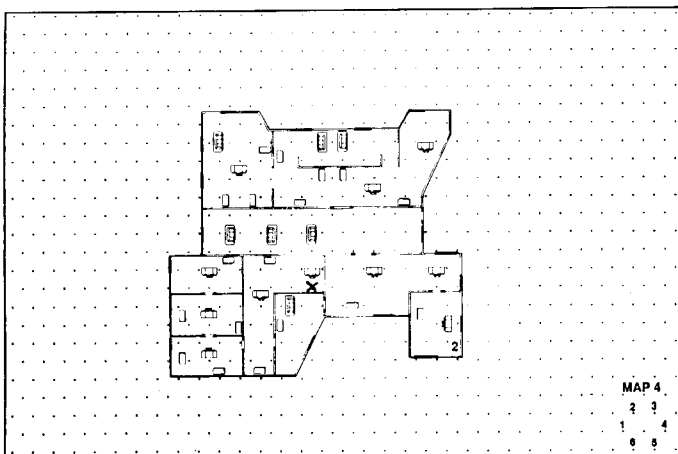

Defender

The Defender is the first and second squads of the Fourth Team, Seventh Kommando, Wolfs Dragoons.

1st Squad (7 Men)

1st Squad Leader and Team commander: Lieutenant Anton Shadd

Leadership Skill Rating: 4

Experience Level: Elite

Equipment (assigned at the player's discretion)

2 SMGs w/Grenade Launchers

1 SMG

1 Lt. MG

2 Blazers

1 SRM

All men are equipped with Flak Vests.

The Player may assign each man a Secondary Weapon of his choice.

2nd Squad (7 Men)

2nd Squad Leader: Sergeant Lester Lukas

Leadership Skill Rating: 3

Experience Level: Elite

Equipment (assigned at the player's discretion)

3 SMGs w/Grenade Launchers

1 Lt. MG

2 Blazers

1 SRM

All men are equipped with Flak Vests.

The Player may assign each man a Secondary Weapon of his choice.

Deployment

Both squads are set up inside the building using the Hidden Units rules. Mark the location of each soldier and the direction that his firing arc is pointing on one of the mapsheets provided with these rules.

One member of the 1st Squad should be designated as Tech Chief Scott. He is always set up at the HPG control chamber. Tech Chief Scott cannot set up a firing arc if he is going to attempt to send the message. See **Special Rules**.

Attacker

The Attacker consists of various units of the An Ting Civilian Guidance Corps, Kurita civilian "volunteers," and one *Vulcan*.

Civilian Guidance Corps Squad (7 Men)

Troop Quality: Green

Leadership Skill Rating: 2

Equipment (assigned at the player's discretion)

3 Rifles w/GL

4 SMGs

Secondary weapons – 7 pistols

Civilian "Volunteer" Squad (7 Men)

Troop Quality: Elite

Leadership Skill Rating: 3

Equipment (assigned at the player's discretion)

3 SMGs w/Grenade Launchers

4 Blazers

All men are equipped with Flak Vests.

The Player may assign each man a Secondary Weapon of his choice.

Vulcan BattleMech

Piloting Skill: 3 Gunnery Skill: 4

Deployment

The Kurita player starts the game with only four Civilian Guidance Corps (CGC) Squads. These squads start off the map. The CGC squads enter the map on Turn 1, at the start of the Kurita player's Movement Phase. One squad should enter from the north, one from the south, one from the east, and one from the west side of the map.

The CGC squads are replaced if they are broken or all of the men of the squad are killed, incapacitated or withdrawn off the map. See **Special Rules** for details.

The *Vulcan* and the Volunteer Squad enter the map from the north side of the map on Turn 5, at the start of the Kurita player's turn.

Victory Conditions

Victory is determined according to the following table:

VICTORY TABLE

Dragoon Decisive Victory	Message Sent and 7 or more Kommandos moved off of the map
Dragoon Substantial Victory	Message Sent and 4 or more Kommandos moved off of the map
Dragoon Marginal Victory	Message Sent
Kurita Marginal Victory	No Message Sent
Kurita Decisive Victory	No Message and no part of the building is rubble or breached or on fire.

The game lasts until all of the Dragoons have been killed, rendered unconscious, or have exited the map.

Special Rules

The Dragoons' mission is to send a coded message through the captured HyperPulse Generator to the other Wolf's Dragoons regiments stationed on other Kurita planets. Upon receipt of this message, the scattered Dragoon units will begin their withdrawal from Kurita space.

Tech Chief Scott is the only man in the team capable of using the ComStar HyperPulse generator. To use the equipment, he must be on the dot which indicates the location of the control panel for the generator. Rather than have Scott perform any action during a turn, the Dragoon player can make a roll to see if Scott was able to send the message. On a result of 10 or more, the message is sent. If Scott is killed or unconscious, the player cannot make the roll. The Dragoon player cannot make a roll if Scott is prone. Remember that if Scott is knocked prone by wounds, he must take an action to get back on his feet.

Once the message is sent, the Dragoon forces may attempt to withdraw off the map. They may exit off any side or sides. Dragoon Kommandos may not leave the building until the message is sent.

The Kurita player starts the game with 4 CGC squads. One squad enters the board from each of the four sides of the map. If a squad breaks, it can be replaced the following turn by a fresh squad, which enters the map from the same side as did the original squad.

On Turn 5, the Kurita player gets a *Vulcan* 'Mech and a elite squad of Kurita soldiers. These units can come in from any side of the map.

Note that the Kurita player is trying to capture the building intact. If any part of the building is breached, rubble, or put on fire, by a Kurita unit, then the most the Kurita player can expect is a marginal victory.



MAP 1

2 3 4
1 6 5

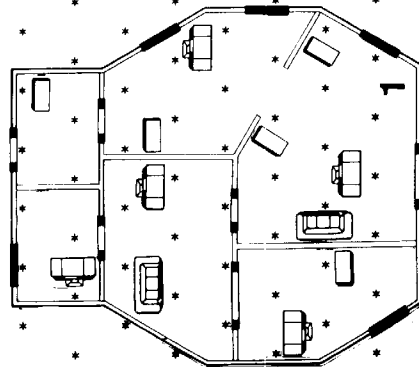
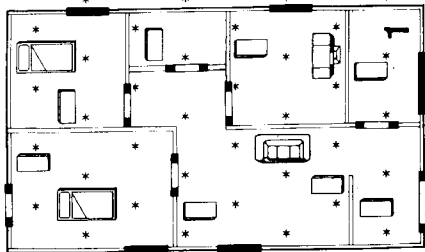
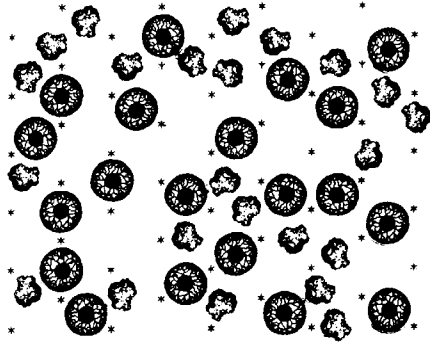
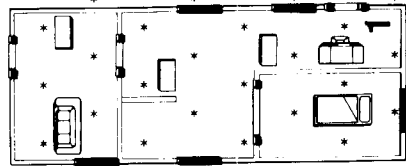
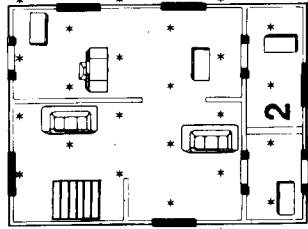

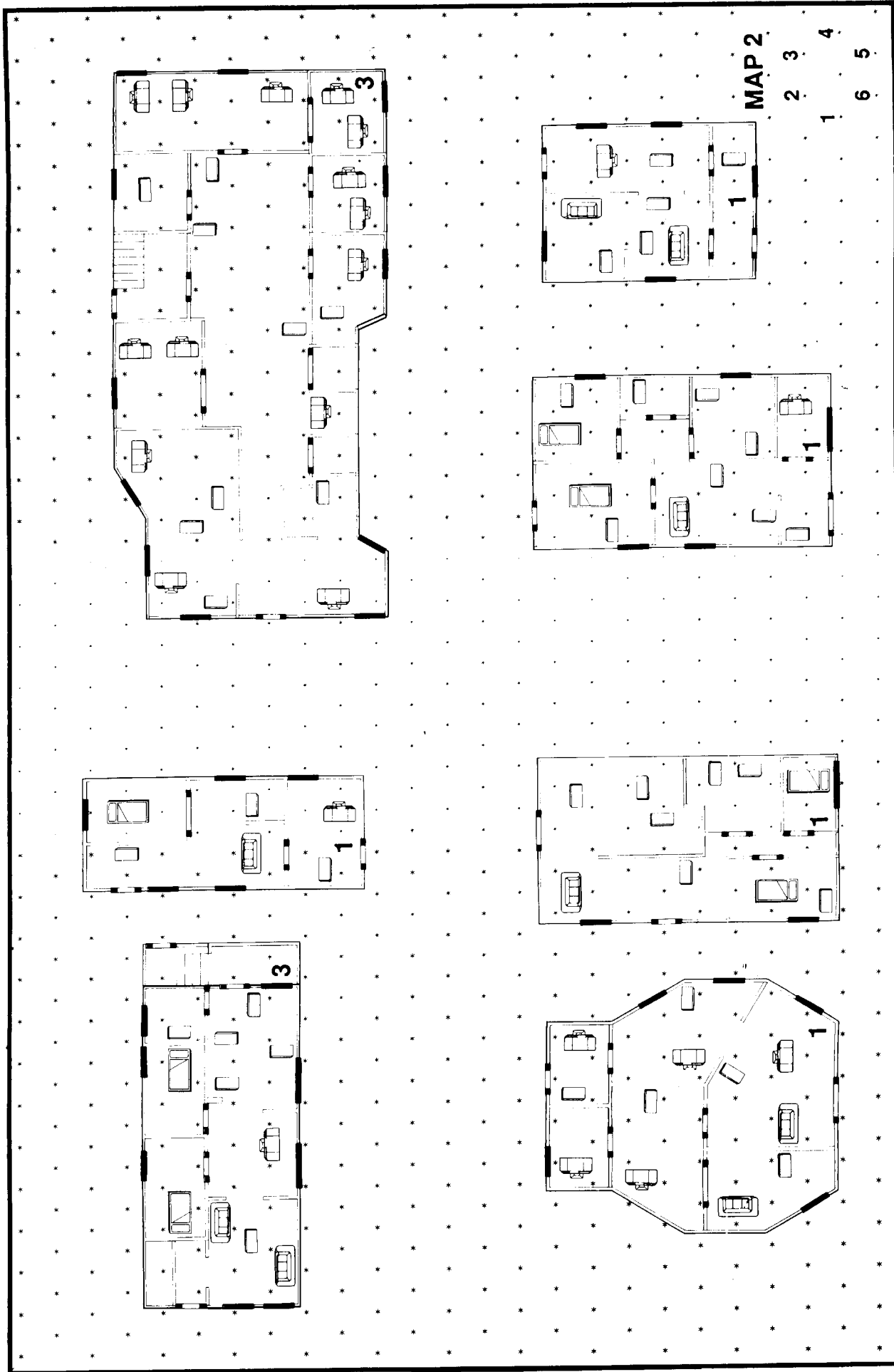

MAP 2
2 3 4
1 6 5

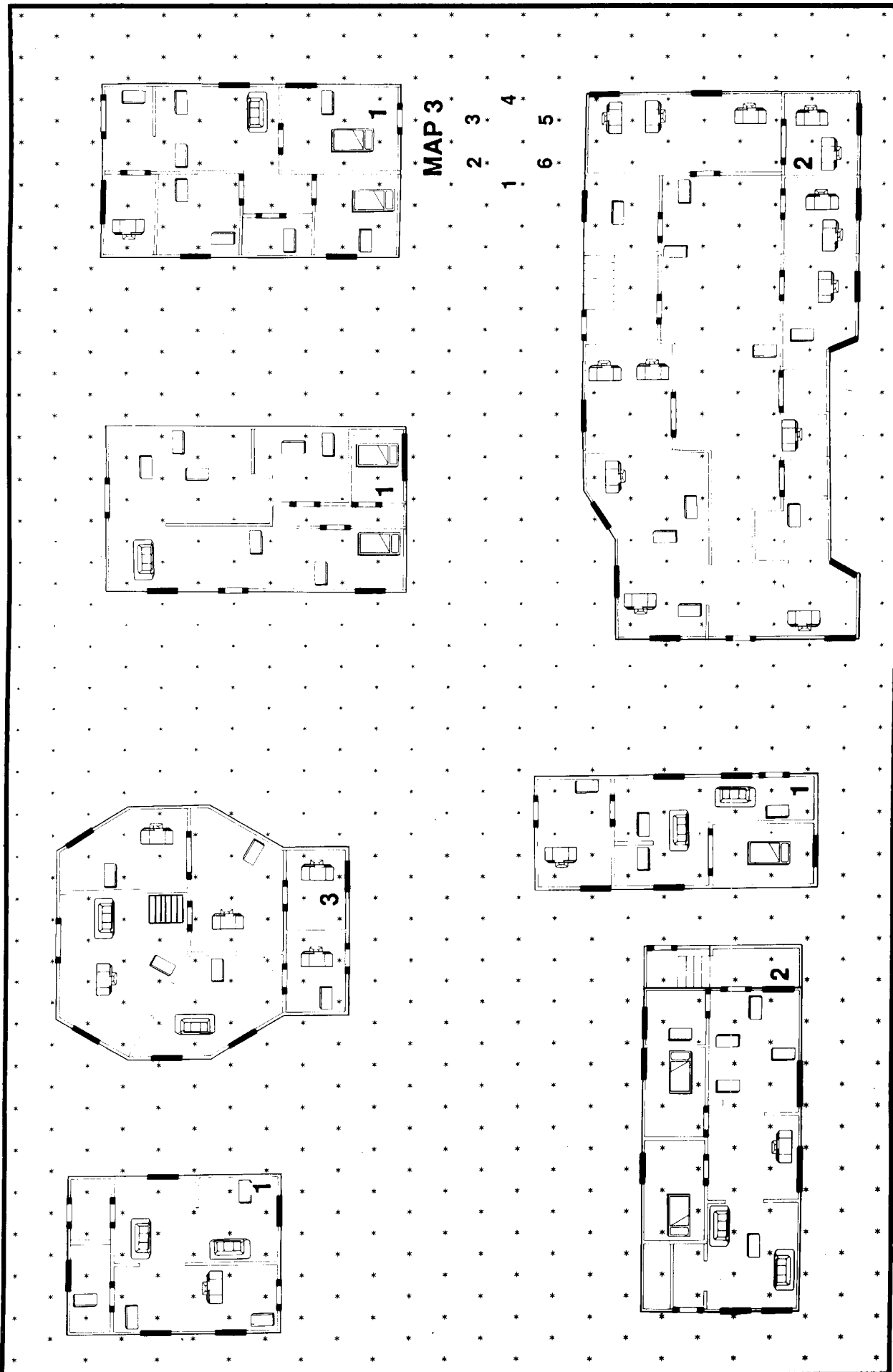

MAP 3

- 2
- 3
- 1
- 4
- 6
- 5

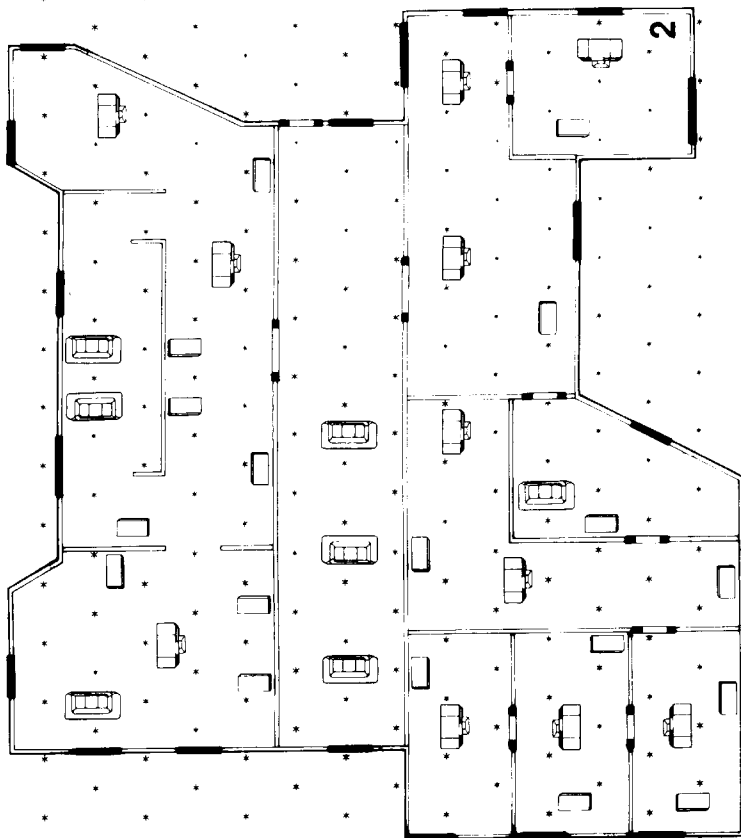

MAP 4

2 3

1 4

6 5

'MECH WEAPON TABLE

Weapon Type	Damage	Range	Minimum	Maximum	MP to Fire
Semi-Automatic					
Small Laser	12L		-	36	-
Medium Laser	20L		-	108	-
Large Laser	32L		-	180	-
PPC	40L		36	216	-
Automatic					
Machine Gun	8L		-	36	-
Area-Effect:					
AC 2	8L/4L/2L		28	288	5
AC 5	20L/10L/5L/2L		36	216	5
AC 10	40L/20L/10L/5L/2L		-	180	5
AC 20	80L/40L/20L/10L/5L/2L		-	108	5
LRM 5	20L/10L/5L/2L		72	252	5
LRM 10	40L/20L/10L/5L/2L		72	252	5
LRM 15	60L/30L/15L/7L/3L/1L		72	252	5
LRM 20	80L/40L/20L/10L/5L/2L		72	252	5
SRM 2	16L/8L/4L/2L		-	108	5
SRM 4	32L/16L/8L/4L/2L		-	108	5
SRM 6	48L/24L/12L/6L/3L/1L		-	108	5
Flamer*	8L/4L/2L		-	36	5

*See Flamer Rules

PERSONAL WEAPON TABLE

Weapon Type	Damage	Short Base 6	Long Base 8
Semi-Automatic Firearms:			
Pistol	3L	1-7	8-20
Rifle	4L	1-27	28-75
Laser Pistol	4L	1-12	13-30
Laser Rifle	5L	1-17	18-105
Gyrojet Rifle	6L	1-57	58-180
Automatic Firearms:			
Blazer	4L	1-17	18-105
Auto Pistol	2L	1-7	8-20
SMG	3L	1-15	16-25
Hand-to-Hand Weapons:			
Blackjack	5B	Adjacent	
Club	4B, 1L	Adjacent	
Stun Stick	8B	Adjacent	
Neural Whip	8B, 3L	Adjacent	
Bayonet/Knife	3L	Adjacent	
Sword	4L	Adjacent	
Vibro-Blade	5L	Adjacent	
Fists	(current MP/2)B	Adjacent	

L = Lethal Damage

* B = Bruise Damage

SUPPORT WEAPONS

Weapon Type	Crew	Damage	APV*	Short Base 6	Long Base 8
Light MG	0	5L	1	1-30	31-84
Medium MG	1	6L	1	1-30	31-84
Heavy MG	2	7L	2	1-36	37-110
Semi-Portable Laser	1	11L	1	1-80	81-240
Heavy Semi-Portable Laser	2	14L	2	1-100	101-280
Man-Pack PPC	0	8L	1	1-50	51-110

*Armor Piercing Value, see BattleTech Integration Section for explanation.

MOVEMENT POINT COST TABLE

Terrain Type	MP Cost
Clear/No Terrain Feature	1
Undergrowth/Tree Branches	2
Contour Line	3
Door	2
Window	4
Furniture	2
Stairways*	+3 (If changing levels)
Walls	Impossible
Tree Trunk	Impossible
Special Actions	
Set Firing Arc	2, 4, or 6
Go Prone	1
Crawl	2x Terrain Cost
Stand Up	2
Prepare Grenade/Weapon	3
Throw Grenade	1 per dot thrown
Engage in Hand-to-Hand	7
Exchange Ammo/Weapon**	6
Set Up/Break Down Support Weapon**	4 per crewmember

* See Stairways

** Optional Rules

AREA-EFFECT WEAPON TABLE

Weapon Type	Damage*	MP to Fire	Ammo	Short	Long
SRM	8/4/2 L	5	2	1-44	45-108
Heavy SRM	13/6/3/1 L	5	1	1-54	55-96
LAW	7/3/1L	4	1	1-22	23-80
Grenade Launcher	4/2/1L	3	4	1-10	11-24
Auto Grenade Launcher	3/2/1L	4	4	1-22	23-50
Light Recoilless Rifle	4/2/1L	4	2	1-36	37-70
Satchel Charge	10/5/2L	3	1	NA	NA
Flamer	2/1L	2	unlimited	1-6	7-12
Heavy Flamer	2/2/1L	4	4	1-6	7-12
Inferno	4/2/1L	5	2	1-44	45-108

*Impact dot/Range 1/Range 2/Range 3

TO-HIT MODIFIERS

Terrain or Action	Modifier
Partial Cover	+1 per partial entered or crossed by LOS
Attacker Prone	-1
Target Prone (Range >1/ Range 1)	+1/-1

PERSONAL ARMOR TABLE

Armor Type	Blocks	MP
Helmet (Assumed and taken into account)		
Flak Vest	2 Blocks	-1 MP
Flak Body Suit	4 Blocks	-2 MP
Combat Armor (Full Suit)	6 Blocks	-3 MP

OTHER BASE TO-HIT NUMBERS

Hand to Hand	4
'Mech Weapons Fire	6
Personal Weapon Vs. 'Mech/Vehicle	11
Area-Effect/Support Weapon Vs. 'Mech/Vehicle	4
Avoid Being Stepped on	5
For each MP <8	+1
Inside Building	+3

BREAKING TABLE

Experience Level	Break Number
Green	9
Regular	7
Veteran	5
Elite	2

Modifiers

Each Additional Loss	+1
Opposing Force Has 'Mech	+1
Squad Leader	-1 per Leadership Skill Level

VEHICLE TABLE

Tonnage	Crew Members
0 -10	1 (Driver only)
11-30	3 (Commander, Gunner, Driver)
30+	4 (Commander, Gunner, Driver, Loader)

